

The background of the entire page is a photograph of a modern, two-story house. The house has white walls and a dark grey roof. The upper level features horizontal wood cladding. A large, dark grey garage door is visible on the left side of the house. The house is set on a paved driveway made of reddish-brown bricks. There are some small plants and a garden bed in front of the house. The sky is blue with some light clouds.

GARADOR
The Garage Door People

The Garador Range Price List

General Information

All prices are quoted in £ Sterling, ex-works and exclusive of VAT.

Our doors are for residential purposes only and not for commercial use.

Please ensure that you order the correct size door to fit your opening as we are unable to accept the return of incorrectly ordered goods. Please contact Garador on 01935 443722 if you need assistance in calculating the correct size. A comprehensive range of the less common accessories and all spare parts are available either online or ask for a current spares price list if required.

Since the company's policy is one of continuous improvement of its products, we reserve the right to make any alterations in design, manufacture or price.

All business is governed by the Company's Standard Conditions and this document does not form any part of any contract with the company and statements contained in it should not be construed as representations or warranties.

For more information please visit
www.garador.co.uk



Contents

4	Frame Dimensions for Panel Doors
6	Steel Panel Doors
19	Guardian Range
22	Design Range
24	GRP Premier Panel Doors
33	Timber Panel Doors
45	Steel and Timber Garage Side Doors
48	Steel and Timber Side-hinged Doors
56	GRP Side Hinged Doors
57	Garage Side Doors & Side-hinged Doors – Specifications
58	Steel Panel Doors – Specifications
62	Steel Sectional Garage Doors
121	Automation and Accessories
127	GaraRoll Roller Doors
133	GaraGlide Roller Doors
139	User Information / Care
142	Warranty
146	Extracts from DHF consumer advice

Frame Dimensions for Panel Doors

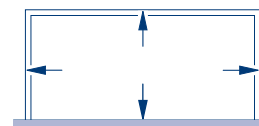
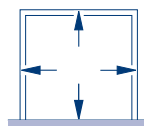
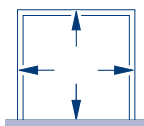
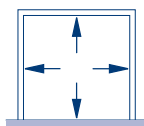

Size Code	Internal frame size On-site timber frame Width x Height (mm x mm)	Pre-framed canopy door overall frame sizes shown ¹ Width x Height (mm x mm)	Pre-framed retractable door overall frame sizes shown ¹ Width x Height (mm x mm)	Frame kit for double door overall frame sizes shown ¹ Width x Height (mm x mm)
6660	1984 x 1830	2094 x 1888	2124 x 1888	-
6663	1984 x 1905	2094 x 1963	2124 x 1963	-
6664	1984 x 1931	2094 x 1989	2124 x 1989	-
6666	1984 x 1981	2094 x 2039	2124 x 2039	-
6670	1984 x 2136	2094 x 2194	2124 x 2194	-
61064	2084 x 1931	2194 x 1989	2224 x 1989	-
61066	2084 x 1981	2194 x 2039	2224 x 2039	-
61070	2084 x 2136	2194 x 2194	2224 x 2194	-
7060	2134 x 1830	2244 x 1888	2274 x 1888	-
7063	2134 x 1905	2244 x 1963	2274 x 1963	-
7064	2134 x 1931	2244 x 1989	2274 x 1989	-
7066	2134 x 1981	2244 x 2039	2274 x 2039	-
7068	2134 x 2036	2244 x 2094	2274 x 2094	-
7070	2134 x 2136	2244 x 2194	2274 x 2194	-
7072	2134 x 2186	2244 x 2244	2274 x 2244	-
7076	2134 x 2286	-	2274 x 2344	-
7163	2170 x 1905	2280 x 1963	2310 x 1963	-
7164	2170 x 1931	2280 x 1989	2310 x 1989	-
7166	2170 x 1981	2280 x 2039	2310 x 2039	-
7168	2170 x 2036	2280 x 2094	2310 x 2094	-
7170	2170 x 2136	2280 x 2194	2310 x 2194	-
7172	2170 x 2186	2280 x 2244	2310 x 2244	-
7176	2170 x 2286	-	2310 x 2344	-
7364	2224 x 1931	2334 x 1989	2364 x 1989	-
7366	2224 x 1981	2334 x 2039	2364 x 2039	-
7368	2224 x 2036	2334 x 2094	2364 x 2094	-
7370	2224 x 2136	2334 x 2194	2364 x 2194	-
7563	2259 x 1905	2369 x 1963	2399 x 1963	-
7564	2259 x 1931	2369 x 1989	2399 x 1989	-
7566	2259 x 1981	2369 x 2039	2399 x 2039	-
7568	2259 x 2036	2369 x 2094	2399 x 2094	-
7570	2259 x 2136	2369 x 2194	2399 x 2194	-
7572	2259 x 2186	2369 x 2244	2399 x 2244	-
7576	2259 x 2286	-	2399 x 2344	-
7663	2284 x 1905	2394 x 1963	2424 x 1963	-
7664	2284 x 1931	2394 x 1989	2424 x 1989	-
7666	2284 x 1981	2394 x 2039	2424 x 2039	-
7668	2284 x 2036	2394 x 2094	2424 x 2094	-
7670	2284 x 2136	2394 x 2194	2424 x 2194	-

¹ No fitting clearance allowed. If door is fitted between the brickwork a minimum of 10 mm clearance over the width and 5 mm over the height should be added to the overall frame size when selecting the door.

Frame Dimensions for Panel Doors

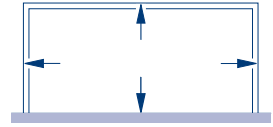
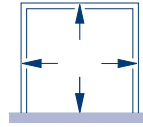
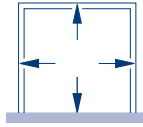
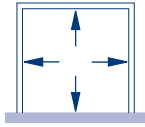

Size Code	Internal frame size On-site timber frame Width x Height (mm x mm)	Pre-framed canopy door overall frame sizes shown ¹ Width x Height (mm x mm)	Pre-framed retractable door overall frame sizes shown ¹ Width x Height (mm x mm)	Frame kit for double door overall frame sizes shown ¹ Width x Height (mm x mm)
7672	2284 x 2186	2394 x 2244	2424 x 2244	-
7676	2284 x 2286	-	2424 x 2344	-
8063	2439 x 1905	2549 x 1963	2579 x 1963	-
8064	2439 x 1931	2549 x 1989	2579 x 1989	-
8066	2439 x 1981	2549 x 2039	2579 x 2039	-
8068	2439 x 2036	2549 x 2094	2579 x 2094	-
8070	2439 x 2136	2549 x 2194	2579 x 2194	-
8072	2439 x 2186	2549 x 2244	2579 x 2244	-
8076	2439 x 2286	-	2579 x 2344	-
8666	2590 x 1981	-	2730 x 2039	-
8670	2590 x 2136	-	2730 x 2194	-
8676	2590 x 2286	-	2730 x 2344	-
9066	2744 x 1981	-	2884 x 2039	-
9070	2744 x 2136	-	2884 x 2194	-
9076	2744 x 2286	-	2884 x 2344	-
1066	3049 x 1981	-	3189 x 2039	-
1070	3049 x 2136	-	3189 x 2194	-
1076	3049 x 2286	-	-	3189 x 2344
1166	3354 x 1981	-	-	3494 x 2039
1170	3354 x 2136	-	-	3494 x 2194
1176	3354 x 2286	-	-	3494 x 2344
1266	3659 x 1981	-	-	3799 x 2039
1270	3659 x 2136	-	-	3799 x 2194
1276	3659 x 2286	-	-	3799 x 2344
1366	3964 x 1981	-	-	4104 x 2039
1370	3964 x 2136	-	-	4104 x 2194
1376	3964 x 2286	-	-	4104 x 2344
1466	4269 x 1981	-	-	4409 x 2039
1468	4269 x 2036	-	-	4409 x 2094
1470	4269 x 2136	-	-	4409 x 2194
1472	4269 x 2186	-	-	4409 x 2244
1476	4269 x 2286	-	-	4409 x 2244
1566	4574 x 1981	-	-	4714 x 2039
1570	4574 x 2136	-	-	4714 x 2194
1666	4879 x 1981	-	-	5019 x 2039
1670	4879 x 2136	-	-	5019 x 2194

¹ No fitting clearance allowed. If door is fitted between the brickwork a minimum of 10 mm clearance over the width and 5 mm over the height should be added to the overall frame size when selecting the door.

Steel Panel Doors

Surface

High quality powder or foil coated finish.

Please note: panel doors are produced with appearance in mind. This may result in some small gaps which could allow water ingress especially in exposed locations.

Colours

All doors supplied in Traffic White (RAL 9016) as standard.

Optional colours available:

- Light Ivory (RAL 1015)
- Ruby Red (RAL 3003)
- Signal Blue (RAL 5005)
- Steel Blue (RAL 5011)
- Stone Grey (RAL 7030)
- Pigeon Blue (RAL 5014)
- Moss Green (RAL 6005)
- Fir Green (RAL 6009)
- Slate Grey (RAL 7015)
- Light grey (RAL 7035)
- Anthracite Grey (RAL 7016)
- Terra Brown (RAL 8028)
- Jet Black (RAL 9005)
- Window Grey (RAL 7040)
- Burgundy Brown
- Golden Brown
- Chartwell Green (BS 4800)
- Agate Grey (RAL 7038)

Timber effect finishes are available in either a Golden Oak or Rosewood foil coat timber effect.

Handle

Black handle as standard, optional handles are available. Doors can be supplied undrilled and without handle and locking mechanism for use with electric operator. This option makes the door purpose made and will therefore increase lead-time, please specify clearly on order (Wentwood and Sherwood designs are not available with no lock hole).

Terminology

Nominal Door Size: This is the actual door panel size plus the fitting tolerances. The nominal door size should be used for internal dimensions of a timber frame.

Size Code: This has traditionally been used to order doors. This may not be the actual door size.

Stock availability

Prices in bold show stock doors in Traffic White (unless specified) and all other prices relate to non-stock doors.

Packaging

All doors are supplied unwrapped as standard, with optional poly-wrapping available.

Steel Panel Doors

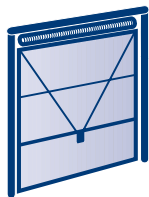

Canopy gearing (shown as C)

Canopy gear is available for all single doors providing a reliable and affordable gearing solution, with no tracks running back into the garage.

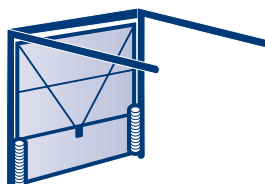

Retractable gearing (shown as R)

Retractable gear is available for all single and double doors providing a reliable and affordable gearing solution, with tracks running back into the garage.

Single Door - Standard Size

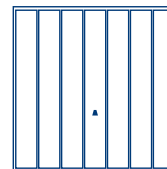
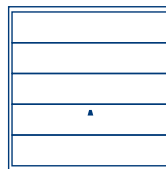
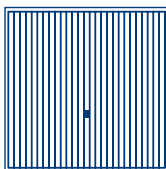
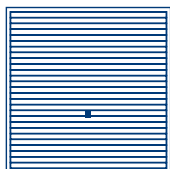

Nominal Door Size Width x Height (mm x mm)	Size Code	Horizon		Carlton		Ascot		Windsor	
		C	R	C	R	C	R	C	R
1984 x 1830	6660	943	993	1067	1118	-	-	-	-
1984 x 1905	6663	943	993	1067	1118	-	-	-	-
1984 x 1931	6664	943	993	1067	1118	-	-	-	-
1984 x 1981	6666	893	944	1014	1065	-	-	-	-
1984 x 2136	6670	893	944	1014	1065	1013	1064	-	-
2084 x 1931	61064	909	960	1013	1064	-	-	-	-
2084 x 1981	61066	935	986	1013	1064	1066	1117	-	-
2084 x 2136	61070	968	1019	1036	1087	1089	1140	-	-
2134 x 1830	7060	969	1020	1096	1147	-	-	-	-
2134 x 1905	7063	921	972	1050	1071	-	-	-	-
2134 x 1931	7064	921	972	1020	1071	-	-	-	-
2134 x 1981	7066	853 ¹	904 ¹	986 ¹	1037 ¹	1040 ¹	1091 ¹	1215	1220
2134 x 2036	7068	974	1025	1078	1129	-	-	1234	1238
2134 x 2136	7070	936 ¹	987 ¹	1028 ¹	1078 ¹	1160 ¹	1211 ¹	1254	1257
2134 x 2186	7072	1010	1061	1103	1154	-	-	1330	1330
2134 x 2286	7076	-	1189	-	1275	-	-	-	-
2170 x 1905	7163	921	972	1020	1071	-	-	-	-
2170 x 1931	7164	921	972	1020	1071	-	-	-	-
2170 x 1981	7166	853	904	986	1037	1040	1091	1215	1220
2170 x 2036	7168	974	1025	1078	1129	-	-	-	-
2170 x 2136	7170	936	987	1028	1078	1160	1211	1254	1257
2170 x 2186	7172	1010	1061	1103	1154	-	-	-	-
2170 x 2286	7176	-	1314	-	1385	-	-	-	-
2224 x 1905	7363	1004	1055	1066	1117	-	-	-	-

Stock doors also available in Jet Black (based on RAL 9005).

¹ Stock doors also available in Anthracite Grey (RAL 7016)

For further options please see page 18.



Steel Panel Doors

Single Door - Standard Size

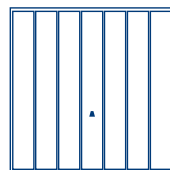
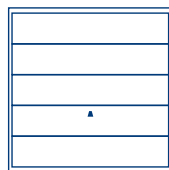
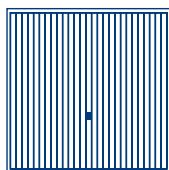
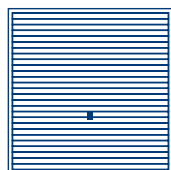

Nominal Door Size Width x Height (mm x mm)	Size Code	Horizon		Carlton		Ascot		Windsor	
		C	R	C	R	C	R	C	R
2224 x 1931	7364	1004	1055	1066	1117	-	-	-	-
2224 x 1981	7366	1007	1058	1071	1122	1124	1175	-	-
2224 x 2036	7368	1048	1099	1137	1187	-	-	-	-
2224 x 2136	7370	1021	1072	1085	1136	1138	1189	-	-
2224 x 2186	7372	1107	1157	1172	1223	-	-	-	-
2259 x 1905	7563	993	1044	1078	1129	-	-	-	-
2259 x 1931	7564	993	1044	1078	1129	-	-	-	-
2259 x 1981	7566	1004	1055	1078	1129	1190	1240	1299	1349
2259 x 2036	7568	1048	1099	1137	1187	-	-	1350	1401
2259 x 2136	7570	1139	1190	1214	1265	1350	1401	1404	1455
2259 x 2186	7572	1226	1277	1256	1307	-	-	1497	1548
2259 x 2286	7576	-	1416	-	1385	-	-	-	-
2284 x 1905	7663	1004	1055	1107	1157	-	-	-	-
2284 x 1931	7664	1004	1055	1107	1157	-	-	-	-
2284 x 1981	7666	1004 ¹	1055 ¹	1107 ¹	1157 ¹	1190	1240	1299	1349
2284 x 2036	7668	1061	1112	1168	1219	-	-	1350	1401
2284 x 2136	7670	1144 ¹	1195 ¹	1214 ¹	1265 ¹	1334 ¹	1385 ¹	1404 ¹	1455 ¹
2284 x 2186	7672	1228	1279	1302 ¹	1353 ¹	-	-	1497	1548
2284 x 2286	7676	-	1420	-	1385	-	-	-	-
2439 x 1905	8063	1156	1207	1310	1361	-	-	-	-
2439 x 1931	8064	1156	1207	1310	1361	-	-	-	-
2439 x 1981	8066	1156	1207	1310	1361	1324	1375	1507	1558
2439 x 2036	8068	1221	1272	1381	1431	-	-	1528	1579
2439 x 2136	8070	1182	1233	1353 ¹	1403 ¹	1368 ¹	1419 ¹	1550	1601
2439 x 2186	8072	1266	1317	1452	1503	-	-	1644	1695
2439 x 2286	8076	-	1386	-	1508	-	-	-	-
2590 x 1981	8666	-	1334	-	1504	-	-	-	-
2590 x 2136	8670	-	1381	-	1564	-	-	-	-
2590 x 2286	8676	-	1523	-	1700	-	-	-	-
2744 x 1981	9066	-	1594	-	1614	-	-	-	-
2744 x 2136	9070	-	1674	-	1700	-	-	-	-
2744 x 2286	9076	-	1739	-	1764	-	-	-	-
3049 x 1981	1066	-	1879	-	1812	-	-	-	-
3049 x 2136	1070	-	1903	-	1833	-	-	-	-

Stock doors also available in Jet Black (based on RAL 9005).

¹ Stock doors also available in Anthracite Grey (RAL 7016)

For further options please see page 18.



Steel Panel Doors

Single Door - Standard Size

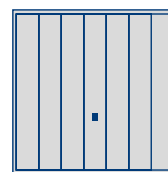
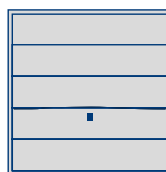
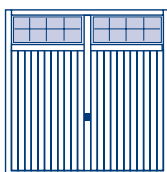
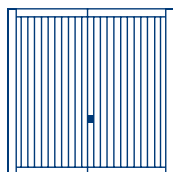

Nominal Door Size Width x Height (mm x mm)	Size Code	Sutton		Salisbury ¹		Wentwood Timber Effect		Sherwood Timber Effect	
		C	R	C	R	C	R	C	R
2134 x 1931	7064	1114	1165	1694	1745	-	-	-	-
2134 x 1981	7066	1055	1105	1694	1745	1097	1148	1273	1323
2134 x 2036	7068	-	-	1785	1836	-	-	-	-
2134 x 2136	7070	1124	1175	1714	1765	1219	1269	1310	1361
2134 x 2186	7072	-	-	1814	1865	-	-	-	-
2134 x 2286	7076	-	-	-	1951	-	-	-	-
2170 x 1905	7163	-	-	-	-	-	-	-	-
2170 x 1931	7164	-	-	1694	1745	-	-	-	-
2170 x 1981	7166	-	-	1694	1745	-	-	-	-
2170 x 2036	7168	-	-	1785	1836	-	-	-	-
2170 x 2136	7170	-	-	1714	1765	-	-	-	-
2170 x 2186	7172	-	-	1814	1865	-	-	-	-
2170 x 2286	7176	-	-	-	1951	-	-	-	-
2224 x 1905	7363	-	-	-	-	-	-	-	-
2224 x 1931	7364	-	-	1761	1812	-	-	-	-
2224 x 1981	7366	-	-	1761	1812	-	-	-	-
2224 x 2036	7368	-	-	-	-	-	-	-	-
2224 x 2136	7370	-	-	1778	1829	-	-	-	-
2224 x 2186	7372	-	-	1878	1929	-	-	-	-
2259 x 1905	7563	-	-	-	-	-	-	-	-
2259 x 1931	7564	1222	1273	1761	1812	-	-	-	-
2259 x 1981	7566	1222	1273	1761	1812	-	-	-	-
2259 x 2036	7568	-	-	1853	1904	-	-	-	-
2259 x 2136	7570	1345	1396	1778	1829	-	-	-	-
2259 x 2186	7572	-	-	1880	1931	-	-	-	-
2259 x 2286	7576	-	-	-	2016	-	-	-	-
2284 x 1905	7663	-	-	-	-	-	-	-	-
2284 x 1931	7664	1235	1286	1761	1812	-	-	-	-
2284 x 1981	7666	1173	1224	1761	1812	1247	1298	1354	1404
2284 x 2036	7668	-	-	1853	1904	-	-	-	-
2284 x 2136	7670	1295	1346	1778 ²	1829 ²	1388	1439	1464	1514
2284 x 2186	7672	-	-	1880	1931	-	-	-	-
2284 x 2286	7676	-	-	-	2016	-	-	-	-
2439 x 1905	8063	-	-	-	-	-	-	-	-
2439 x 1931	8064	1361	1412	1870	1921	-	-	-	-
2439 x 1981	8066	1361	1412	1870	1921	1380	1430	1560	1611
2439 x 2036	8068	-	-	1963	2014	-	-	-	-
2439 x 2136	8070	1385	1436	1886	1937	1429	1480	1610	1661
2439 x 2186	8072	-	-	1988	2039	-	-	-	-

¹ Salisbury windows (with window icon) come as white as standard, colour match windows are available to order as an option, see page 10.

² Also available on 1 week lead time in Jet Black (RAL 9005) with black colour match windows.

Please note that doors with windows may have cross bracing or locking rods passing behind the windows depending upon size and gear type.

Stock doors also available in Jet Black (based on RAL 9005).

Wentwood and Sherwood models are only available in either a Golden Oak or Rosewood foil coat timber effect finish. For further options please see page 18.



Steel Panel Doors

Single Door - Standard Size

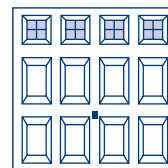
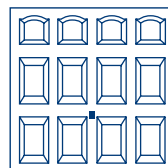
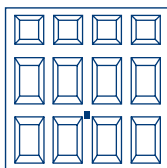
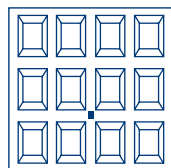

Nominal Door Size Width x Height (mm x mm)	Size Code	Georgian		Beaumont		Cathedral		Beaumont with Windows ¹	
		C	R	C	R	C	R	C	R
1984 x 1931	6664	1305	1356	1305	1356	1305	1356	1776	1827
1984 x 1981	6666	1236	1287	1236	1287	1236	1287	1783	1834
1984 x 2136	6670	1255	1306	1255	1306	1255	1306	1725	1776
2084 x 1931	61064	1251	1302	1251	1302	1251	1302	1721	1772
2084 x 1981	61066	1253	1304	1253	1304	1253	1304	1723	1774
2084 x 2136	61070	1343	1394	1343	1394	1343	1394	1811	1862
2134 x 1931	7064	1253	1304	1253	1304	1253	1304	1723	1774
2134 x 1981	7066	1253	1304	1253	1304	1253	1304	1723	1774
2134 x 2136	7070	1328	1378	1328	1378	1328	1378	1795	1846
2134 x 2286	7076	-	1579	-	1579	-	1579	-	2046
2170 x 1931	7164	1253	1304	1253	1304	1253	1304	1723	1774
2170 x 1981	7166	1253	1304	1253	1304	1253	1304	1723	1774
2170 x 2136	7170	1328	1378	1328	1378	1328	1378	1795	1846
2170 x 2286	7176	-	1705	-	1705	-	1705	-	2177
2224 x 1931	7364	1392	1443	1392	1443	1392	1443	1865	1916
2224 x 1981	7366	1399	1450	1399	1450	1399	1450	1872	1922
2224 x 2136	7370	1408	1458	1408	1458	1408	1458	1879	1930
2259 x 1931	7564	1392	1443	1392	1443	1392	1443	1865	1916
2259 x 1981	7566	1392	1443	1392	1443	1392	1443	1865	1916
2259 x 2136	7570	1601	1651	1601	1651	1601	1651	2077	2128
2259 x 2286	7576	-	1944	-	1944	-	1944	-	2413
2284 x 1931	7664	1392	1443	1392	1443	1392	1443	1865	1916
2284 x 1981	7666	1392	1443	1392	1443	1392	1443	1865	1916
2284 x 2136	7670	1601	1651	1601	1651	1601	1651	2077	2128

¹ Windows for Beaumont: Standard (□), Diamond (◊), Cross (⊕). Please state on order if clear or crystal panes, see page 11.

Please note that doors with windows may have cross bracing or locking rods passing behind the windows depending upon size and gear type.

Stock doors also available in Jet Black (based on RAL 9005).

For further options please see page 18.

Steel Panel Doors

Single Door - Standard Size

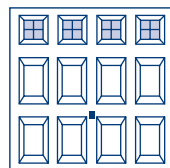
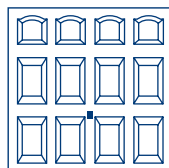
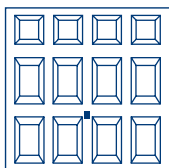
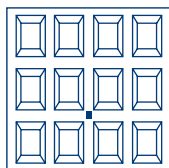

Nominal Door Size Width x Height (mm x mm)	Size Code	Georgian		Beaumont		Cathedral		Beaumont with Windows ¹	
		C	R	C	R	C	R	C	R
2284 x 2286	7676	-	1944	-	1944	-	1944	-	2413
2439 x 1931	8064	1647	1698	1647	1698	1647	1698	2119	2169
2439 x 1981	8066	1647	1698	1647	1698	1647	1698	2119	2169
2439 x 2136	8070	1717	1768	1717	1768	1717	1768	2186	2237
2439 x 2286	8076	-	1907	-	1907	-	1907	-	2453
2590 x 1981	8666	-	1757	-	1757	-	1757	-	2300
2590 x 2136	8670	-	1777	-	1777	-	1777	-	2324
2590 x 2286	8676	-	1969	-	1969	-	1969	-	2511
2744 x 1981	9066	-	1783	-	1783	-	1783	-	2331
2744 x 2136	9070	-	1807	-	1807	-	1807	-	2350
2744 x 2286	9076	-	1995	-	1995	-	1995	-	2543
3049 x 1981	1066	-	1850	-	1850	-	1850	-	2399
3049 x 2136	1070	-	1888	-	1888	-	1888	-	2439

¹ Windows for Beaumont: Standard (□), Diamond (◊), Cross (⊕). Please state on order if clear or crystal panes, see page 11.

Please note that doors with windows may have cross bracing or locking rods passing behind the windows depending upon size and gear type.

Stock doors also available in Jet Black (based on RAL 9005).

For further options please see page 18.



Steel Panel Doors

Single Door - Purpose Made Size

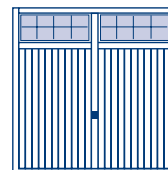
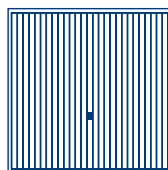
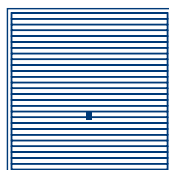

Nominal Door Size Width x Height (mm x mm)	Horizon		Carlton		Salisbury	
	C	R	C	R	C	R
1830-1930 x 1830-1930	1242	1293	1290	1341	-	-
1830-1930 x 1931-1981	1289	1340	1337	1388	-	-
1830-1930 x 1982-2136	1386	1437	1415	1466	-	-
1830-1930 x 2137-2186	1471	1522	1500	1551	-	-
1830-1930 x 2187-2286	-	1559	-	1612	-	-
1830-1930 x 2287-2439	-	-	-	1717	-	-
1931-1984 x 1830-1930	1251	1302	1305	1356	-	-
1931-1984 x 1931-1981	1298	1348	1348	1399	-	-
1931-1984 x 1982-2136	1376	1427	1420	1471	-	-
1931-1984 x 2137-2186	1460	1511	1505	1556	-	-
1931-1984 x 2187-2286	-	1559	-	1612	-	-
1931-1984 x 2287-2439	-	1672	-	1717	-	-
1985-2134 x 1830-1930	1298	1348	1346	1397	-	-
1985-2134 x 1931-1981	1376	1427	1420	1471	-	-
1985-2134 x 1982-2136	1485	1536	1513	1564	-	-
1985-2134 x 2137-2186	1570	1621	1597	1648	-	-
1985-2134 x 2187-2286	-	1672	-	1717	-	-
1985-2134 x 2287-2439	-	1777	-	1809	-	-
2135-2284 x 1830-1930	1376	1427	1403	1454	-	-
2135-2284 x 1931-1981	1485	1536	1513	1564	-	-
2135-2284 x 1982-2136	1579	1630	1629	1679	2031	2082
2135-2284 x 2137-2186	1663	1714	1714	1765	2116	2167
2135-2284 x 2187-2286	-	1777	-	1809	-	2425
2135-2284 x 2287-2439	-	1887	-	1935	-	-
2285-2499 ¹ x 1830-1930	1485	1536	1529	1580	-	-
2285-2499 ¹ x 1931-1981	1579	1630	1629	1679	-	-
2285-2499 ¹ x 1982-2136	1590	1641	1717	1768	2243	2294
2285-2499 ¹ x 2137-2186	1674	1725	1801	1852	2328	2379
2285-2499 x 2187-2286	-	1812	-	1850	-	2377
2285-2499 x 2287-2439	-	1888	-	1908	-	-
2500-2590 x 1830-1930	-	1700	-	1730	-	-
2500-2590 x 1931-1981	-	1777	-	1809	-	-
2500-2590 x 1982-2136	-	1888	-	1888	-	-
2500-2590 x 2137-2286	-	1908	-	1908	-	-
2500-2590 x 2287-2439	-	2024	-	2024	-	-
2591-2722 x 1830-1930	-	1807	-	1807	-	-
2591-2722 x 1931-1981	-	1879	-	1879	-	-
2591-2722 x 1982-2136	-	2010	-	2010	-	-

¹ Canopy gear only available up to 2439 wide.

Orders for purpose made sizes will only be accepted as nominal door size for unframed version and overall frame size when ordering a framed version. Orders for purpose made framed doors will not be accepted as nominal door size. For further options please see page 18.



Steel Panel Doors

Single Door - Purpose Made Size

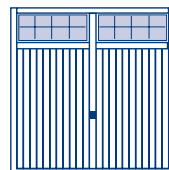
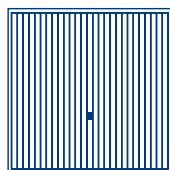
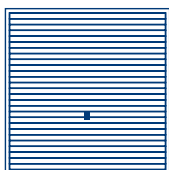

Nominal Door Size Width x Height (mm x mm)	Horizon		Carlton		Salisbury	
	C	R	C	R	C	R
2591-2722 x 2137-2286	-	2135	-	2135	-	-
2591-2722 x 2287-2439	-	2276	-	2276	-	-
2723-3049 x 1830-1930	-	-	-	2198	-	-
2723-3049 x 1931-1981	-	-	-	2275	-	-
2723-3049 x 1982-2136	-	-	-	2507	-	-

¹ Canopy gear only available up to 2439 wide.

Orders for purpose made sizes will only be accepted as nominal door size for unframed version and overall frame size when ordering a framed version. Orders for purpose made framed doors will not be accepted as nominal door size. For further options please see page 18.

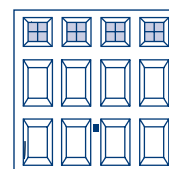
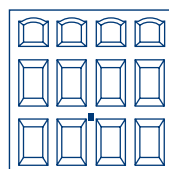
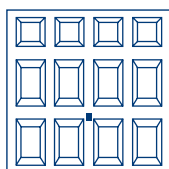
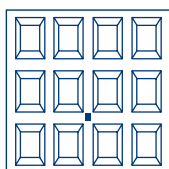

Nominal Door Size Width x Height (mm x mm)	Georgian		Beaumont		Cathedral		Beaumont with Windows ²	
	C	R	C	R	C	R	C	R
1830-1930 x 2137-2186	1993	2044	1993	2044	1993	2044	2464	2515
1931-1984 x 2137-2186	1993	2044	1993	2044	1993	2044	2464	2515
1985-2134 x 1931-1981	1956	2006	1956	2006	1956	2006	2426	2477
1985-2134 x 1982-2136	2078	2129	2078	2129	2078	2129	2548	2599
1985-2134 x 2137-2186	2162	2213	2162	2213	2162	2213	2632	2683
1985-2134 x 2187-2286	-	2283	-	2283	-	2283	-	2753
1985-2134 x 2287-2439	-	2201	-	2201	-	2201	-	2671
2135-2284 x 1931-1981	2095	2146	2095	2146	2095	2146	2568	2619
2135-2284 x 1982-2136	2095	2146	2095	2146	2095	2146	2568	2619
2135-2284 x 2137-2186	2180	2231	2180	2231	2180	2231	2652	2703
2135-2284 x 2187-2286	-	2261	-	2261	-	2261	-	2734
2135-2284 x 2287-2439	-	2574	-	2574	-	2574	-	3044
2285-2499 ¹ x 1931-1981	2222	2273	2222	2273	2222	2273	2697	2748
2285-2499 ¹ x 1982-2136	2260	2311	2260	2311	2260	2311	2733	2784
2285-2499 ¹ x 2137-2186	2415	2466	2415	2466	2415	2466	2928	2979
2285-2499 x 2187-2286	-	2405	-	2405	-	2405	-	2876
2285-2439 x 2187-2286	-	2405	-	2405	-	2405	-	2876

¹ Canopy gear only available up to 2439 wide.

² Windows for Beaumont: Standard (□), Diamond (◊), Cross (⊕). Please state on order if clear or crystal panes.

Orders for purpose made sizes will only be accepted as nominal door size for unframed version and overall frame size when ordering a framed version. Orders for purpose made framed doors will not be accepted as nominal door size.

Please note that doors with windows may have cross bracing or locking rods passing behind the windows depending upon size and gear type.

For further options please see page 18.



Steel Panel Doors

Single Door - Purpose Made Size

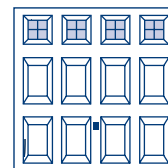
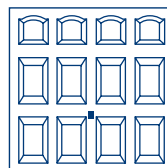
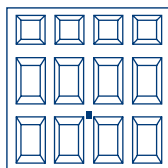
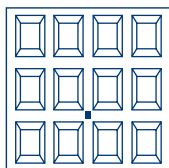

Nominal Door Size Width x Height (mm x mm)	Georgian		Beaumont		Cathedral		Beaumont with Windows ²	
	C	R	C	R	C	R	C	R
2285-2499 x 2287-2439	-	2503	-	2503	-	2503	-	2973
2500-2590 x 1931-1981	-	2384	-	2384	-	2384	-	2857
2500-2590 x 1982-2136	-	2422	-	2422	-	2422	-	2896
2500-2590 x 2137-2286	-	2478	-	2478	-	2478	-	2950
2500-2590 x 2287-2439	-	2559	-	2559	-	2559	-	3026
2591-2722 x 1931-1981	-	2395	-	2395	-	2395	-	2866
2591-2722 x 1982-2136	-	2508	-	2508	-	2508	-	2983
2591-2722 x 2137-2286	-	2584	-	2584	-	2584	-	3057
2723-3049 x 1931-1981	-	2559	-	2559	-	2559	-	3026
2723-3049 x 1982-2136	-	2654	-	2654	-	2654	-	3124

¹ Canopy gear only available up to 2439 wide.

² Windows for Beaumont: Standard () , Diamond () , Cross () . Please state on order if clear or crystal panes.

Orders for purpose made sizes will only be accepted as nominal door size for unframed version and overall frame size when ordering a framed version. Orders for purpose made framed doors will not be accepted as nominal door size.

Please note that doors with windows may have cross bracing or locking rods passing behind the windows depending upon size and gear type.

For further options please see page 18.

Steel Panel Doors

Double Door - Standard Size

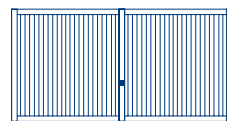
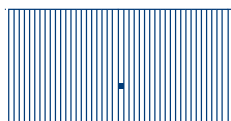

Nominal Door Size Width x Height (mm x mm)	Size Code	Horizon			Carlton		Sutton	
		R	R	R	R	R	R	
3049 x 2286	1076	2433			2433			-
3354 x 1981	1166	2275			2275			-
3354 x 2136	1170	2293			2293			-
3354 x 2286	1176	2351			2351			-
3659 x 1981	1266	2389			2389			-
3659 x 2136	1270	2407			2407			-
3659 x 2286	1276	2577			2577			-
3964 x 1981	1366	2599			2599			-
3964 x 2136	1370	2619			2619			-
3964 x 2286	1376	2869			2869			-
4269 x 1981	1466	2505			2505			2708
4268 x 2036	1468	2505			2505			-
4269 x 2136	1470	2505			2505			2708
4268 x 2186	1472	2656			2656			-
4269 x 2286	1476	2808			2808			-
4574 x 1981	1566	2697			2697			2901
4574 x 2136	1570	2736			2736			2941
4879 x 1981	1666	2852			2852			3056
4879 x 2136	1670	2889			2889			3092

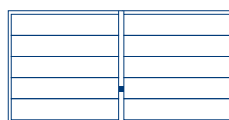
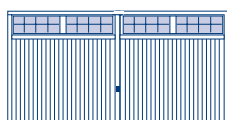

Nominal Door Size Width x Height (mm x mm)	Size Code	Salisbury		Ascot		Windsor	
		R	R	R	R	R	R
4269 x 1981	1466	3467		2648		2648	
4268 x 2036	1468	-		-		-	
4269 x 2136	1470	3467		2648		2648	
4268 x 2186	1472	3618					
4269 x 2286	1476	3770					

Please note that doors with windows may have cross bracing or locking rods passing behind the windows depending upon size and gear type.

For further options please see page 18.



Steel Panel Doors

Double Door - Standard Size

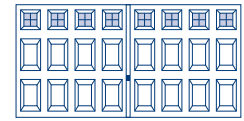
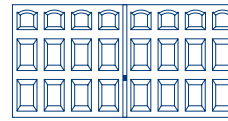
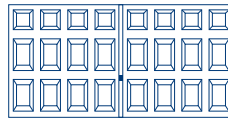
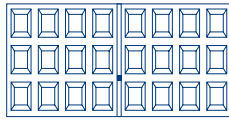

Nominal Door Size Width x Height (mm x mm)	Size Code	Georgian		Beaumont		Cathedral		Beaumont with Windows ¹	
		R		R		R		R	
3049 x 2286	1076	2433		2433		2433		3134	
3354 x 1981	1166	2389		2389		2389		3098	
3354 x 2136	1170	2389		2389		2389		3098	
3354 x 2286	1176	2582		2582		2582		3289	
3659 x 1981	1266	2544		2544		2544		3251	
3659 x 2136	1270	2544		2544		2544		3251	
3659 x 2286	1276	2660		2660		2660		3366	
3964 x 1981	1366	2620		2620		2620		3327	
3964 x 2136	1370	2620		2620		2620		3327	
3964 x 2286	1376	2660		2660		2660		3381	
4269 x 1981	1466	2697		2697		2697		3402	
4269 x 2136	1470	2697		2697		2697		3402	
4574 x 1981	1566	2929		2929		2929		3633	
4574 x 2136	1570	2929		2929		2929		3633	
4879 x 1981	1666	3081		3081		3081		3791	
4879 x 2136	1670	3081		3081		3081		3791	

¹ Windows for Beaumont: Standard (□), Diamond (◊), Cross (⊕). Please state on order if clear or crystal panes.

Please note that doors with windows may have cross bracing or locking rods passing behind the windows depending upon size and gear type.

For further options please see page 18.

Steel Panel Doors

Double Door - Purpose Made Size

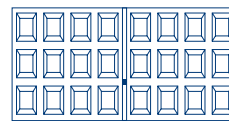
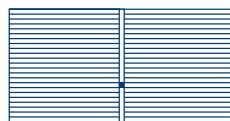
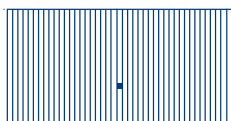

Nominal Door Size Width x Height (mm x mm)	Carlton			Horizon			Georgian		
			R			R			R
2745-3049	x	2137-2286	2812			-			2812
3050-3354	x	1886-1981	2660			2697			2774
3050-3354	x	1982-2136	2680			2716			2812
3050-3354	x	2137-2286	2929			2967			2967
3355-3659	x	1886-1981	2736			2774			2929
3355-3659	x	1982-2136	2793			2831			3005
3355-3659	x	2137-2286	2929			2967			3042
3660-3967	x	1886-1981	2985			3024			3005
3660-3967	x	1982-2136	3042			3081			3042
3660-3967	x	2137-2286	3256			3291			3081
3968-4269	x	1886-1981	2889			2929			3081
3968-4269	x	1982-2136	2929			2967			3081
4270-5000	x	1886-1981	3199			3233			3467
4270-5000	x	1982-2136	3274			3312			3467

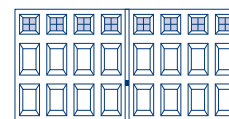
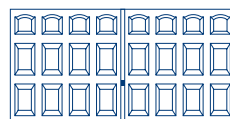
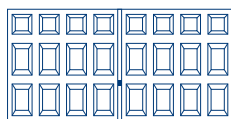

Nominal Door Size Width x Height (mm x mm)	Beaumont			Cathedral			Beaumont with Windows ¹		
			R			R			R
2745-3049	x	2137-2286	2812			2812			3297
3050-3354	x	1886-1981	2774			2774			3482
3050-3354	x	1982-2136	2812			2812			3521
3050-3354	x	2137-2286	2967			2967			3678
3355-3659	x	1886-1981	2929			2929			3633
3355-3659	x	1982-2136	3005			3005			3713
3355-3659	x	2137-2286	3042			3042			3751
3660-3967	x	1886-1981	3005			3005			3943
3660-3967	x	1982-2136	3042			3042			3984
3660-3967	x	2137-2286	3081			3081			4023
3968-4269	x	1886-1981	3081			3081			4023
3968-4269	x	1982-2136	3081			3081			4023
4270-5000	x	1886-1981	3467			3467			4643
4270-5000	x	1982-2136	3467			3467			4643

¹ Windows for Beaumont: Standard (□), Diamond (◊), Cross (⊕). Please state on order if clear or crystal panes.

Orders for purpose made sizes will only be accepted as nominal door size for unframed version and overall frame size when ordering a framed version. Orders for purpose made framed doors will not be accepted as nominal door size.

Please note that doors with windows may have cross bracing or locking rods passing behind the windows depending upon size and gear type.

For further options please see page 18.



Steel Panel Doors

Options		
	Single doors	Double doors
	add	add
Factory pre-framed standard single doors	191	-
Steel frame for standard double doors	-	286
Factory pre-framed purpose-made single doors (framed retractable purpose made doors require a 4 week lead-time)	216	
Steel frame for purpose made double doors	-	318
Additional Lock Kit, C-type/ R-type (fitted onto door)	89	-
Retractable plus gear available on 1931, 1981 and 2136 mm high doors up to 2744 mm wide	91	-
For powder-coated doors: Moss Green (RAL 6005), Ruby Red (RAL 3003), Signal Blue (RAL 5005), Jet Black (RAL 9005), Steel Blue (RAL 5011), Light Ivory (RAL 1015), Pigeon Blue (RAL 5014), Fir Green (RAL 6009), Anthracite Grey (RAL 7016), Stone Grey (RAL 7030), Light Grey (RAL 7035), Slate Grey (RAL 7015), Agate Grey (RAL 7038), Window Grey (RAL 7040), Chartwell Green (BS 4800), Burgundy Brown ² , Golden Brown ² and Terra Brown (RAL 8028).	189	295
Coloured window frames to match door colour – Beaumont doors (price per window). ¹ Beaumont doors up to 3049 wide = 4 windows, between 3050 to 3964 = 6 windows, between 3965 to 4860 = 8 windows and over 4860 = 10 windows ² .	70 each	70 each
¹ Coloured window frames to match door colour – Salisbury doors (price per door) ²	237	465
Black window panes for Salisbury doors (price per door)	54	101
Poly-wrapping	51	92
Diecast metal handles: brass effect, chrome effect, brushed steel and white	105	105
Bottom weatherseal, 2405 mm length (suitable for gaps up to 15 mm between the door and the floor level)	65	65
Bottom weatherseal, 3000 mm length (suitable for gaps up to 15 mm between the door and the floor level)	73	73
Surcharge on White RAL 9016 doors for colour steel frame in RAL colour not matching Garage door	189	295

¹ Please state coloured windows required on order. Coloured Beaumont with windows and Salisbury doors are supplied with white window frames as standard.

² Colour match windows not available in Burgundy Brown or Golden Brown.

Please note that doors with windows may have cross bracing or locking rods passing behind the windows depending upon size and gear type.

Guardian Range

Secured By Design certified Up & Over doors

These doors have been tested to the STS 202 Security Technical Specification and achieve Secured By Design accreditation. Lock body protection, anti-snap cylinder, high security bracing and improved lock security make these doors even more secure.

Information

- Guardian Range doors come with a pre-fitted steel frame and cannot be fitted to a custom made timber frame.
- Guardian Range doors are not suitable for automation. Only available with canopy or retractable lifting gear.
- Retractable plus not available.
- Window panes on Secured by Design Salisbury doors are black non-translucent.

Single door – standard sizes

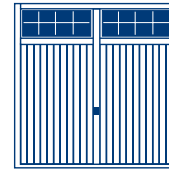
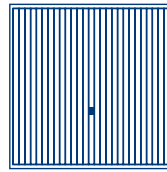
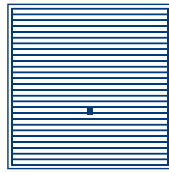

Nominal Door Size Width x Height (mm x mm)	Size Code	Horizon		Carlton		Salisbury	
		C	R	C	R	C	R
1984 x 1830	6660	1586	1637	1718	1769	-	-
1984 x 1905	6663	1586	1637	1718	1769	-	-
1984 x 1931	6664	1586	1637	1718	1769	-	-
1984 x 1981	6666	1542	1593	1665	1716	-	-
1984 x 2136	6670	1559	1610	1665	1716	-	-
2084 x 1931	61064	1559	1610	1665	1716	-	-
2084 x 1981	61066	1581	1632	1665	1716	-	-
2084 x 2136	61070	1614	1665	1683	1733	-	-
2134 x 1830	7060	1616	1667	1743	1794	-	-
2134 x 1905	7063	1566	1617	1668	1719	-	-
2134 x 1931	7064	1566	1617	1668	1719	2345	2396
2134 x 1981	7066	1464	1514	1634	1685	2345	2396
2134 x 2031	7068	1657	1708	1761	1812	-	-
2134 x 2136	7070	1582	1633	1676	1727	2362	2413
2134 x 2186	7072	-	1743	-	1845	-	-
2170 x 1931	7164	1657	1708	1738	1788	-	-
2170 x 1981	7166	1464	1514	1634	1685	-	-
2170 x 2036	7168	1657	1708	1761	1812	-	-
2170 x 2136	7170	1683	1733	1792	1842	-	-
2170 x 2186	7172	-	1756	-	1864	-	-

Secured by Design



Police Preferred Specification

Secured by Design is an association focusing on the design of more secure homes and commercial properties. Secured by Design is owned by the ACPO (Association of Chief Police Officers) and awards the Secured by Design status to products that pass their extensive testing procedures.

Guardian Range

Single door – standard sizes

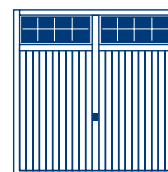
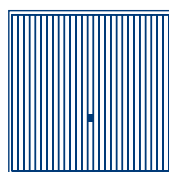
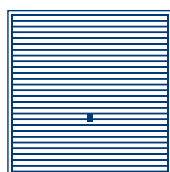

Nominal Door Size Width x Height (mm x mm)	Size Code	Horizon		Carlton		Salisbury	
		C	R	C	R	C	R
2224 x 1931	7364	1648	1699	1717	1768	-	-
2224 x 1981	7366	1657	1708	1721	1772	-	-
2224 x 2136	7370	1671	1722	1733	1784	-	-
2259 x 1931	7564	1701	1752	1773	1824	2408	2459
2259 x 1981	7566	1648	1699	1725	1776	2408	2459
2259 x 2036	7568	1790	1840	1862	1913	-	-
2259 x 2136	7570	1790	1840	1862	1913	2426	2477
2259 x 2286	7572	-	1862	-	1936	-	-
2284 x 1931	7664	1648	1699	1756	1807	2408	2459
2284 x 1981	7666	1648	1699	1756	1807	2408	2459
2284 x 2031	7668	1742	1793	1855	1906	-	-
2284 x 2136	7670	1792	1842	1862	1913	2426	2477
2284 x 2186	7672	-	-	-	2040	-	-
2439 x 1931	8064	-	-	-	2033	-	2591
2439 x 1981	8066	-	-	-	2033	-	2591
2439 x 2031	8068	-	-	-	2148	-	-
2439 x 2136	8070	-	-	-	2078	-	2613
2439 x 2186	8072	-	-	-	2194	-	-
2590 x 1981	8666	-	-	-	2150	-	-
2590 x 2136	8670	-	-	-	2213	-	-
2744 x 1981	9066	-	-	-	2258	-	-
2744 x 2136	9070	-	-	-	2346	-	-

Single door – purpose-made sizes

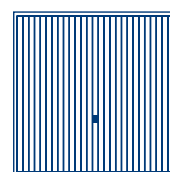
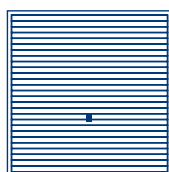

Nominal Door Size Width x Height (mm x mm)		Size Code	Horizon		Carlton	
			C	R	C	R
1985-2134	x	1830-1930	1945	1996	1993	2044
1985-2134	x	1931-1981	2022	2073	2075	2126
1985-2134	x	1982-2136	2135	2186	2162	2213
2135-2284	x	1830-1930	2022	2073	2052	2103
2135-2284	x	1931-1981	2135	2186	2135	2186
2135-2284	x	1982-2136	2223	2274	2274	2325
2285-2499	x	1830-1930	-	-	-	2217
2285-2499	x	1931-1981	-	-	-	2307

Orders for purpose made sizes will only be accepted as overall frame size when ordering a framed version. Orders for purpose made framed doors will not be accepted as nominal door size.

For further options please see page 21.

Guardian Range

Single door – purpose-made sizes

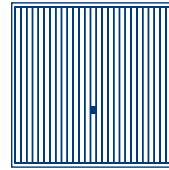
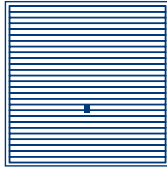

Nominal Door Size Width x Height (mm x mm)	Horizon		Carlton	
	C	R	C	R
2285-2499 x 1982-2136	-	-	-	2394
2500-2590 x 1830-1930	-	-	-	2336
2500-2590 x 1931-1981	-	-	-	2407
2500-2590 x 1982-2136	-	-	-	2488
2591-2722 x 1830-1930	-	-	-	2405
2591-2722 x 1931-1981	-	-	-	2476
2591-2722 x 1982-2136	-	-	-	2603

Orders for purpose made sizes will only be accepted as overall frame size when ordering a framed version. Orders for purpose made framed doors will not be accepted as nominal door size.

Options for single doors

	add
For powder coated doors: Moss Green (RAL 6005), Ruby Red (RAL 3003), Signal Blue (RAL 5005), Jet Black (RAL 9005), Steel Blue (RAL 5011), Light Ivory (RAL 1015), Pigeon Blue (RAL 5014), Fir Green (RAL 6009), Anthracite Grey (RAL 7016), Stone Grey (RAL 7030), Light Grey (RAL 7035), Slate Grey (RAL 7015), Agate Grey (RAL 7038), Window Grey (RAL 7040), Chartwell Green (BS 4800), Burgundy Brown ² , Golden Brown ² and Terra Brown (RAL 8028).	189
Coloured window frames on Salisbury to match door colour ¹	237
Poly-wrapping	51

¹ Colour match windows not available in Burgundy Brown or Golden Brown.

Design Range

Surface and finish

The Series 100 Design Range skins are built from four horizontal skins, whilst the Series 200 range is constructed from three vertical skins. Stainless steel elements on Garador design range doors are manufactured from high grade 2 mm thick steel with a brushed finish. The series 100 and 200 design range doors are also available without stainless steel elements. On Design Range doors a choice of any standard colour comes free of charge, please see page 23 for a choice of the 19 standard RAL colours available.

Please note: panel doors are produced with appearance in mind. This may result in some small gaps which could allow water ingress especially in exposed locations.

Handle

A new perfectly matched handle offers a quality feel everytime you open the door.

Terminology

Nominal Door Size: This is the actual door panel size plus the fitting tolerances. The nominal door size should be used for internal dimensions of a timber frame.

Size Code: This has traditionally been used to order doors. This may not be the actual door size.

Design Options - Standard Size

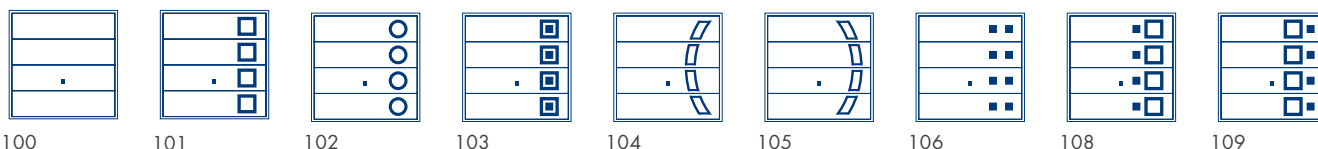

Nominal Door Size Width x Height (mm x mm)	Size Code	100		101		102		103		104	
		C	R	C	R	C	R	C	R	C	R
2134 x 1981	7066	1449	1500	1737	1787	1737	1787	1737	1787	1737	1787
2134 x 2136	7070	1545	1595	1832	1883	1832	1883	1832	1883	1832	1883
2259 x 1981	7566	1594	1645	1880	1931	1880	1931	1880	1931	1880	1931
2259 x 2136	7570	1688	1739	1978	2029	1978	2029	1978	2029	1978	2029
2284 x 1981	7666	1623	1674	1908	1959	1908	1959	1908	1959	1908	1959
2284 x 2136	7670	1718	1769	2005	2056	2005	2056	2005	2056	2005	2056
2439 x 1981	8066	1832	1883	2119	2169	2119	2169	2119	2169	2119	2169
2439 x 2136	8070	1928	1978	2216	2267	2216	2267	2216	2267	2216	2267

Nominal Door Size Width x Height (mm x mm)	Size Code	105		106		108		109	
		C	R	C	R	C	R	C	R
2134 x 1981	7066	1737	1787	1737	1787	1737	1787	1737	1787
2134 x 2136	7070	1832	1883	1832	1883	1832	1883	1832	1883
2259 x 1981	7566	1880	1931	1880	1931	1880	1931	1880	1931
2259 x 2136	7570	1978	2029	1978	2029	1978	2029	1978	2029
2284 x 1981	7666	1908	1959	1908	1959	1908	1959	1908	1959
2284 x 2136	7670	2005	2056	2005	2056	2005	2056	2005	2056
2439 x 1981	8066	2119	2169	2119	2169	2119	2169	2119	2169
2439 x 2136	8070	2216	2267	2216	2267	2216	2267	2216	2267

Design Range

Design Options - Standard Size

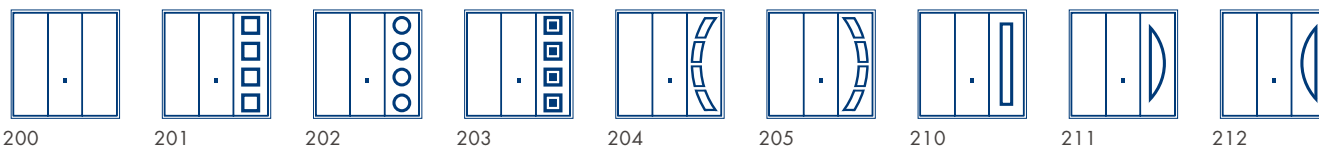

Nominal Door Size Width x Height (mm x mm)	Size Code	200		201		202		203		204	
		C	R	C	R	C	R	C	R	C	R
2134 x 1981	7066	1449	1500	1737	1787	1737	1787	1737	1787	1737	1787
2134 x 2136	7070	1545	1595	1832	1883	1832	1883	1832	1883	1832	1883
2259 x 1981	7566	1594	1645	1880	1931	1880	1931	1880	1931	1880	1931
2259 x 2136	7570	1688	1739	1978	2029	1978	2029	1978	2029	1978	2029
2284 x 1981	7666	1623	1674	1908	1959	1908	1959	1908	1959	1908	1959
2284 x 2136	7670	1718	1769	2005	2056	2005	2056	2005	2056	2005	2056
2439 x 1981	8066	1832	1883	2119	2169	2119	2169	2119	2169	2119	2169
2439 x 2136	8070	1928	1978	2216	2267	2216	2267	2216	2267	2216	2267

Nominal Door Size Width x Height (mm x mm)	Size Code	205		210		211		212	
		C	R	C	R	C	R	C	R
2134 x 1981	7066	1737	1787	1737	1787	1737	1787	1737	1787
2134 x 2136	7070	1832	1883	1832	1883	1832	1883	1832	1883
2259 x 1981	7566	1880	1931	1880	1931	1880	1931	1880	1931
2259 x 2136	7570	1978	2029	1978	2029	1978	2029	1978	2029
2284 x 1981	7666	1908	1959	1908	1959	1908	1959	1908	1959
2284 x 2136	7670	2005	2056	2005	2056	2005	2056	2005	2056
2439 x 1981	8066	2119	2169	2119	2169	2119	2169	2119	2169
2439 x 2136	8070	2216	2267	2216	2267	2216	2267	2216	2267

Options for single doors

	add
Factory pre-fitted steel frame	191
Additional Lock Kit, C-type/ R-type (fitted onto door)	89
Retractable plus gear	91
Poly-wrapping	51

Please specify on order if you would like the design elements on the right or the left hand side of the door panel (viewed from outside).

Colour options on Design Range doors are free of charge. Available options are: White (RAL 9016), Terra Brown (RAL 8028), Moss Green (RAL 6005), Ruby Red (RAL 3003), Signal Blue (RAL 5005), Jet Black (RAL 9005), Steel Blue (RAL 5011), Light Ivory (RAL 1015), Pigeon Blue (RAL 5014), Fir Green (RAL 6009), Anthracite Grey (RAL 7016), Stone Grey (RAL 7030), Light Grey (RAL 7035), Slate Grey (RAL 7015), Agate Grey (RAL 7038), Window Grey (RAL 7040), Chartwell Green (BS 4800), Burgundy Brown and Golden Brown (solid).



GRP Premier Panel Doors

Surface

High gloss or woodgrain finish depending on door style.

GRP Premier doors are constructed as an infill panel and are fixed into a rigid box section chassis.

The infill has a flow coat to the inside face for a smoother finish and reduced translucency.

Please note: panel doors are produced with appearance in mind. This may result in some small gaps which could allow water ingress especially in exposed locations

Standard colours

Arden and Stamford are available in Gloss White and Gloss Magnolia finish only. All other doors are available in the following range of woodgrain colours: White, Magnolia, Bleached Oak, Red Mahogany, Dark Mahogany, Light Oak, Dark Oak, Irish Oak, Honey Beech, Teak, Golden Brown, Ebony and Anthracite Grey.

Due to the production processes door colours may vary. Should you require matching doors please specify on your order.

Please note when trying to colour match garage doors with other UPVC products always check a colour sample first. The gel coats used in the process will not necessarily be a match and we will not guarantee a match with any other product.

Premium colours

Our GRP premium colour range includes Blue and Green. There is an additional surcharge for these colours, see page 26 for details.

Chassis colour

Traffic White (RAL 9016) for White Woodgrain and Gloss White doors, Black (RAL 9005) for Ebony coloured doors, Anthracite Grey (RAL 7016) for Anthracite Grey doors, Light Ivory (RAL 1015) for Magnolia Gloss and Magnolia doors, Fir Green (RAL 6009) for Green doors and Steel Blue (RAL 5011) for Blue doors.

Burgundy Brown will be used as the chassis colour for Red Mahogany, Dark Oak and Dark Mahogany. All other doors will be supplied with a Terra Brown (RAL 8028) chassis.

Handle

Black handle and base plate as standard, optional handles available. Doors can be supplied undrilled and without handle and locking mechanism for use with electric operator. This must be requested at the time of order.

Certain panel configurations may only be available without handle or locking, therefore only suitable for electric operation (consult Garador sales office for exact details).

GRP Premier Panel Doors

Terminology

Nominal Door Size: This is the actual door panel size plus the fitting tolerances. The nominal door size should be used for internal dimensions of a timber frame.

Size Code: This has traditionally been used to order doors. This may not be the actual door size.

Packaging

Supplied with front surface protection as standard.

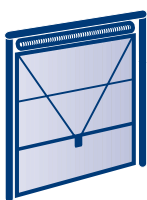

Canopy gearing (shown as C)

Canopy gear is available for all single doors providing a reliable and affordable gearing solution, with no tracks running back into the garage.

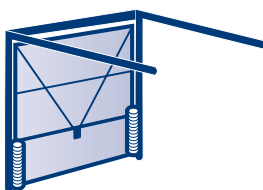

Retractable gearing (shown as R)

Retractable gear is available for all single and double doors providing a reliable and affordable gearing solution, with tracks running back into the garage.

Single Door - Standard Size

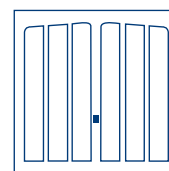
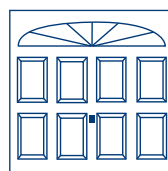
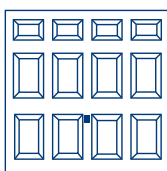
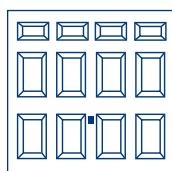

Nominal Door Size Width x Height (mm x mm)	Size Code	Arden		Kenmore		Stamford		Penshurst	
		C	R	C	R	C	R	C	R
2134 x 1981	7066	2390	2441	2390	2441	2390	2441	2390	2441
2134 x 2136	7070	2390	2441	2390	2441	2390	2441	2390	2441
2259 x 1981	7566	2450	2501	2450	2501	2450	2501	2450	2501
2259 x 2136	7570	2450	2501	2450	2501	2450	2501	2450	2501
2284 x 1981	7666	2500	2551	2500	2551	2500	2551	2500	2551
2284 x 2136	7670	2500	2551	2500	2551	2500	2551	2500	2551
2439 x 1981	8066	2550	2601	2550	2601	2550	2601	2550	2601
2439 x 2136	8070	2550	2601	2550	2601	2550	2601	2550	2601
2744 x 1981	9066	-	2830 ¹	-	2830 ¹	-	-	-	-
2744 x 2136	9070	-	2830 ¹	-	2830 ¹	-	-	-	-
3049 x 1981	1066	-	3115 ¹	-	3115 ¹	-	-	-	-
3049 x 2136	1070	-	3115 ¹	-	3115 ¹	-	-	-	-

¹ Doors only available with electric operation (Handle and Locking not available).

For further options please see page 32.



GRP Premier Panel Doors

Single Door - Standard Size

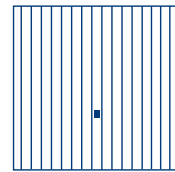
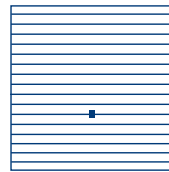
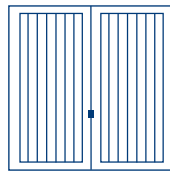

Nominal Door Size Width x Height (mm x mm)	Size Code	Swinton		Glastonbury		Somerset	
		C	R	C	R	C	R
2134 x 1981	7066	2390	2441	2390	2441	2390	2441
2134 x 2136	7070	2390	2441	2390	2441	2390	2441
2259 x 1981	7566	2450	2501	2450	2501	2450	2501
2259 x 2136	7570	2450	2501	2450	2501	2450	2501
2284 x 1981	7666	2500	2551	2500	2551	2500	2551
2284 x 2136	7670	2500	2551	2500	2551	2500	2551
2439 x 1981	8066	2550	2601	-	-	2550	2601
2439 x 2136	8070	2550	2601	-	-	2550	2601
2744 x 1981	9066	-	-	-	-	-	2830
2744 x 2136	9070	-	-	-	-	-	2830
3049 x 1981	1066	-	-	-	-	-	3115
3049 x 2136	1070	-	-	-	-	-	3115

Please note that doors with windows may have cross bracing or locking rods passing behind the windows depending upon size and gear type.

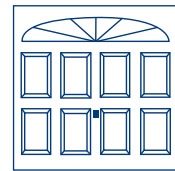
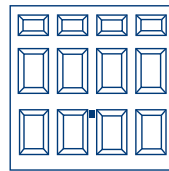
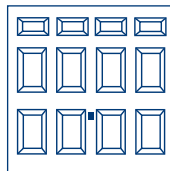

Nominal Door Size Width x Height (mm x mm)	Size Code	Arden with Windows		Kenmore with Windows		Stamford with Windows	
		C	R	C	R	C	R
2134 x 1981	7066	2910	2961	2910	2961	2910	2961
2134 x 2136	7070	2910	2961	2910	2961	2910	2961
2259 x 1981	7566	2970	3021	2970	3021	2970	3021
2259 x 2136	7570	2970	3021	2970	3021	2970	3021
2284 x 1981	7666	3020	3071	3020	3071	3020	3071
2284 x 2136	7670	3020	3071	3020	3071	3020	3071
2439 x 1981	8066	3070	3121	3070	3121	3070	3121
2439 x 2136	8070	3070	3121	3070	3121	3070	3121
2744 x 1981	9066	-	3506 ¹	-	3506 ¹	-	-
2744 x 2136	9070	-	3506 ¹	-	3506 ¹	-	-
3049 x 1981	1066	-	3791 ¹	-	3791 ¹	-	-
3049 x 2136	1070	-	3791 ¹	-	3791 ¹	-	-

For further options please see page 32.



GRP Premier Panel Doors

Single Door - Purpose Made Size

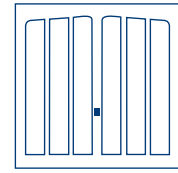
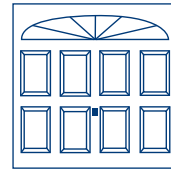
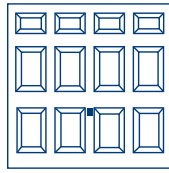
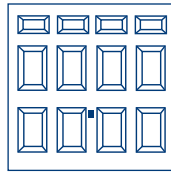

Nominal Door Size Width x Height (mm x mm)	Arden		Kenmore		Stamford		Penshurst	
	C	R	C	R	C	R	C	R
2032-2133 x 1931-1980	-	-	-	-	-	-	2540	2591
2032-2133 x 1981-2136	-	-	-	-	-	-	2540	2591
2032-2133 x 2137-2286	-	-	-	-	-	-	-	2741
2134-2439 x 1931-1980	-	-	-	-	-	-	2700	2751
2134-2439 x 1981-2136	2700	2751	2700	2751	2700	2751	2700	2751
2134-2439 x 2137-2286	-	2901	-	2901	-	-	-	2901
2591-2744 x 1981-2136	-	-	-	2980 ¹	-	-	-	-
2591-2744 x 2137-2286	-	-	-	-	-	-	-	-
2745-2896 x 1931-1980	-	-	-	-	-	-	-	-
2745-2896 x 1981-2136	-	3265 ¹	-	3265 ¹	-	-	-	-
2745-2896 x 2137-2286	-	-	-	-	-	-	-	-
2897-3049 x 1931-1980	-	-	-	-	-	-	-	-
2897-3049 x 1981-2136	-	3265 ¹	-	3265 ¹	-	-	-	-
2897-3049 x 2137-2286	-	-	-	-	-	-	-	-

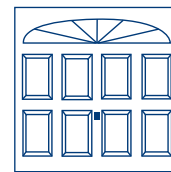
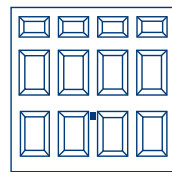
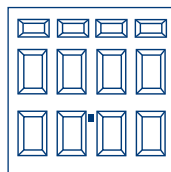

Nominal Door Size Width x Height (mm x mm)	Arden with windows		Kenmore with windows		Stamford with windows	
	C	R	C	R	C	R
2134-2439 x 1981-2136	3220	3271	3220	3271	3220	3271
2134-2439 x 2137-2286	-	3421	-	3421	-	-
2591-2744 x 1981-2136	-	-	-	3656 ¹	-	-
2745-2896 x 1981-2136	-	3941 ¹	-	3941 ¹	-	-
2897-3049 x 1981-2136	-	3941 ¹	-	3941 ¹	-	-

¹ Doors only available with electric operation (Handle and Locking not available).



GRP Premier Panel Doors

Single Door - Purpose Made Size

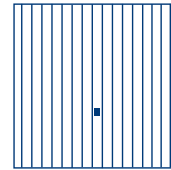
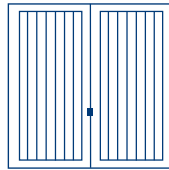

Nominal Door Size Width x Height (mm x mm)	Swinton			Somerset	
		C	R	C	R
2259-2439 x 1981-2136	2700	2751	2700	2751	
2259-2439 x 2137-2286	-	2901	-	2901	
2440-2590 x 1931-1980	-	-	-	2980	
2440-2590 x 1981-2136	-	-	-	2980	
2440-2590 x 2137-2286	-	-	-	3130	
2591-2744 x 1931-1980	-	-	-	2980	
2591-2744 x 1981-2136	-	-	-	2980	
2591-2744 x 2137-2286	-	-	-	3130	
2745-2896 x 1931-1980	-	-	-	3265	
2745-2896 x 1981-2136	-	-	-	3265	
2745-2896 x 2137-2286	-	-	-	3415	
2897-3049 x 1931-1980	-	-	-	3265	
2897-3049 x 1981-2136	-	-	-	3265	
2897-3049 x 2137-2286	-	-	-	3415	

Orders for purpose made sizes will only be accepted as nominal door size for unframed version and overall frame size when ordering a framed version. Orders for purpose made framed doors will not be accepted as nominal door size.

Please note that doors with windows may have cross bracing or locking rods passing behind the windows depending upon size and gear type.

For further options please see page 32.

GRP Premier Panel Doors

Double Door - Standard Size

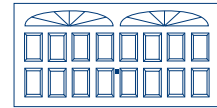
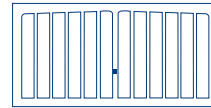
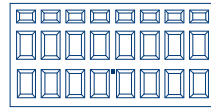
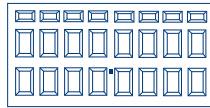

Nominal Door Size Width x Height (mm x mm)	Size Code	Arden		Kenmore		Penshurst		Stamford	
		R	R	R	R	R	R	R	R
3354 x 1981	1166	4320		4320		-		-	
3354 x 2136	1170	4320		4320		-		-	
3354 x 2286	1176	4470		-		-		-	
3659 x 1981	1266	4630		4630		-		-	
3659 x 2136	1270	4630		4630		-		-	
3659 x 2286	1276	4780		-		-		-	
3964 x 1981	1366	4890		4890		-		-	
3964 x 2136	1370	4890		4890		-		-	
3964 x 2286	1376	5040		-		-		-	
4269 x 1981	1466	5150		5150		5150		5150 ¹	
4269 x 2136	1470	5150		5150		5150		5150 ¹	
4269 x 2286	1476	5300		-		-		-	

¹ Doors only available with electric operation (Handle and Locking not available).

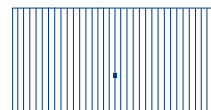
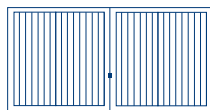

Nominal Door Size Width x Height (mm x mm)	Size Code	Swinton		Somerset	
		R	R	R	R
3354 x 1981	1166	-		4320	
3354 x 2136	1170	-		4320	
3354 x 2286	1176	-		-	
3659 x 1981	1266	-		4630	
3659 x 2136	1270	-		4630	
3659 x 2286	1276	-		-	
3964 x 1981	1366	-		4890	
3964 x 2136	1370	-		4890	
3964 x 2286	1376	-		-	
4269 x 1981	1466	-		5150	
4269 x 2136	1470	5150		5150	
4269 x 2286	1476	-		-	

¹ Doors only available with electric operation (Handle and Locking not available).

Please note that doors with windows may have cross bracing or locking rods passing behind the windows depending upon size and gear type.

For further options please see page 32.

GRP Premier Panel Doors

Double Door - Standard Size

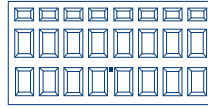
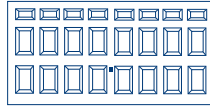

Nominal Door Size Width x Height (mm x mm)	Size Code	Arden with windows		Kenmore with windows		Stamford with windows	
		R		R		R	
3354 x 1981	1166	4996		4996		-	
3354 x 2136	1170	4996		4996		-	
3354 x 2286	1176	5246		-		-	
3659 x 1981	1266	5306		5306		-	
3659 x 2136	1270	5306		5306		-	
3659 x 2286	1276	5556		-		-	
3964 x 1981	1366	5566		5566		-	
3964 x 2136	1370	5566		5566		-	
3964 x 2286	1376	5816		-		-	
4269 x 1981	1466	5826		5826		5826	
4269 x 2136	1470	5826		5826		5826	
4269 x 2286	1476	6076		-		-	

Double Door - Purpose Made Size

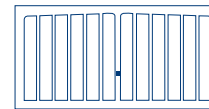
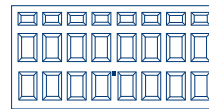
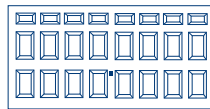

Nominal Door Size Width x Height (mm x mm)			Arden		Kenmore		Penshurst	
			R		R		R	
3050-3355	x	1981-2136	4570		4570		-	
3050-3355	x	2137-2286	4820		-		-	
3356-3660	x	1981-2136	4880 ¹		4880 ¹		-	
3356-3660	x	2137-2286	5130		-		-	
3661-3965	x	1981-2136	5140 ¹		5140 ¹		-	
3661-3965	x	2137-2286	5390		-		-	
3966-4117	x	1981-2136	5400 ¹		5400 ¹		-	
3966-4117	x	2137-2286	5650		-		-	
4118-4269	x	1981-2136	5400		5400		5400	
4118-4269	x	2137-2286	5650		-		-	

Orders for purpose made sizes will only be accepted as nominal door size for unframed version and overall frame size when ordering a framed version. Orders for purpose made framed doors will not be accepted as nominal door size.

GRP Premier Panel Doors

Double Door - Purpose Made Size

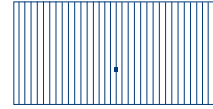
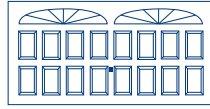

Nominal Door Size Width x Height (mm x mm)	Stamford			Somerset
			R	R
3050-3355 x 1981-2136	-	-	-	4570
3050-3355 x 2137-2286	-	-	-	4820
3356-3660 x 1981-2136	-	-	-	4880
3356-3660 x 2137-2286	-	-	-	5130
3661-3965 x 1981-2136	-	-	-	5140
3661-3965 x 2137-2286	-	-	-	5390
3966-4117 x 1981-2136	-	-	-	5400
3966-4117 x 2137-2286	-	-	-	5650
4118-4269 x 1981-2136	5400 ¹	-	-	5400
4118-4269 x 2137-2286	-	-	-	5650

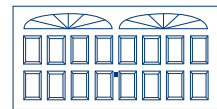
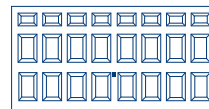
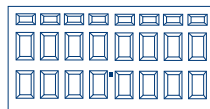

Nominal Door Size Width x Height (mm x mm)	Arden with windows		Kenmore with Windows	Stamford with windows
		R	R	R
3050-3355 x 1981-2136	5246	5246	-	-
3050-3355 x 2137-2286	5496	-	-	-
3356-3660 x 1981-2136	5556 ¹	5556 ¹	-	-
3356-3660 x 2137-2286	5806	-	-	-
3661-3965 x 1981-2136	5816 ¹	5816 ¹	-	-
3661-3965 x 2137-2286	6066	-	-	-
3966-4117 x 1981-2136	6076 ¹	6076 ¹	-	-
3966-4117 x 2137-2286	6326	-	-	-
4118-4269 x 1981-2136	6076	6076	6076	6076
4118-4269 x 2137-2286	6326	-	-	-







¹ Doors only available with electric operation (Handle and Locking not available).

Orders for purpose made sizes will only be accepted as nominal door size for unframed version and overall frame size when ordering a framed version. Orders for purpose made framed doors will not be accepted as nominal door size.

GRP Premier Panel Doors

Options		
	Single doors add	Double doors add
Factory pre-framed standard single doors	191	-
Steel frame for standard double doors	-	286
Factory pre-framed purpose-made single doors	216	-
Steel frame for purpose-made double doors	-	318
Additional Lock Kit, C-type/ R-type (fitted onto door)	89	-
Retractable plus gear available on 1931, 1981 and 2136 mm high doors up to 2744 mm wide	91	-
Diecast metal handles with matching base plates: brass effect, brushed steel, chrome effect and white	133	133
Surcharge for Premium colours Green and Blue	436	866
Surcharge for steel frame in colour not matching garage door	189	295
Surcharge for colour steel frame on Matt or Gloss White Garage door	189	295

GRP Window options

	Stamford	Arden	Kenmore
 Clear Perspex	X	X	X
 Stippled Perspex	X	X	X
 Stippled Perspex with diamond leading	-	X	X
 Stippled Perspex with square leading	-	X	X
 Black Non-Translucent	X	X	X
 Black Non-Translucent Perspex with border and diamond leading	-	X	X

Please state window code on order.

Timber Panel Doors

Surface

Timber doors are supplied untreated and require immediate on-site finishing unless fully finished option specified. Timber is a natural material and therefore Garador cannot guarantee to be able to produce matching timber garage doors. Chassis colours will be Brown (RAL 8028) on all timber doors

Please note: panel doors are produced with appearance in mind. This may result in some small gaps which could allow water ingress especially in exposed locations.

Handle

Black handle and base plate supplied as standard, optional handles available. Doors can alternatively be supplied undrilled and without handle and locking mechanism for use with electric operator.

Packaging

Supplied wrapped with additional foam protection on surface of panel as standard.

Terminology

Nominal Door Size: This is the actual door panel size plus the fitting tolerances. The nominal door size should be used for internal dimensions of a timber frame.

Size Code: This has traditionally been used to order doors. This may not be the actual door size.

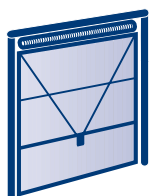

Canopy gearing (shown as C)

Canopy gear is available for all single doors providing a reliable and affordable gearing solution, with no tracks running back into the garage.

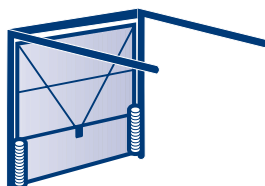

Retractable gearing (shown as R)

Retractable gear is available for all single and double doors providing a reliable and affordable gearing solution, with tracks running back into the garage.

Timber Panel Doors

Single Door - Standard Size

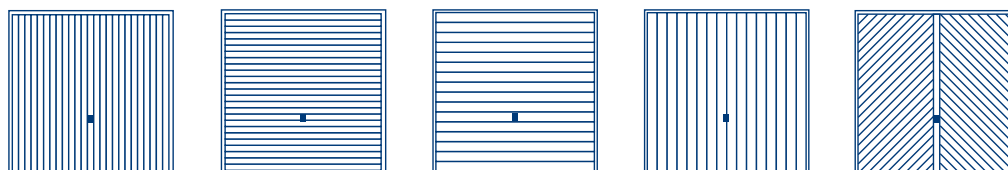

Nominal Door Size Width x Height (mm x mm)	Size Code	Vertical Timber		Horizontal Timber		Countryman		Hampton		Chevron Timber	
		C	R	C	R	C	R	C	R	C	R
2134 x 1981	7066	3009	3060	3166	3217	3758	3808	3758	3808	4474	4525
2134 x 2136	7070	3039	3090	3194	3245	3789	3840	3789	3840	4545	4596
2134 x 2286	7076	-	3439	-	3612	-	4260	-	4260	-	4798
2259 x 1981	7566	3166	3217	3331	3382	3952	4003	3952	4003	4773	4824
2259 x 2136	7570	3195	3246	3363	3414	3986	4037	3986	4037	4796	4846
2284 x 1981	7666	3166	3217	3650	3700	3952	4003	3952	4003	4773	4824
2284 x 2136	7670	3195	3246	3363	3414	3986	4037	3986	4037	4796	4846
2284 x 2286	7676	-	3567	-	3751	-	4273	-	4273	-	5032
2439 x 1981	8066	3352	3403	3527	3578	4178	4229	4178	4229	4931	4981
2439 x 2136	8070	3376	3426	3553	3604	4211	4262	4211	4262	4959	5009
2439 x 2286	8076	-	3785	-	3969	-	4529	-	4529	-	5166
2744 x 1981	9066	-	3949	-	4150	-	4715	-	4715	-	5498
2744 x 2136	9070	-	3976	-	4174	-	4765	-	4765	-	5576
2744 x 2286	9076	-	4337	-	4561	-	5102	-	5102	-	5763
3049 x 1981	1066	-	4571	-	4796	-	5325	-	5325	-	6172
3049 x 2136	1070	-	4613	-	4848	-	5369	-	5369	-	6221

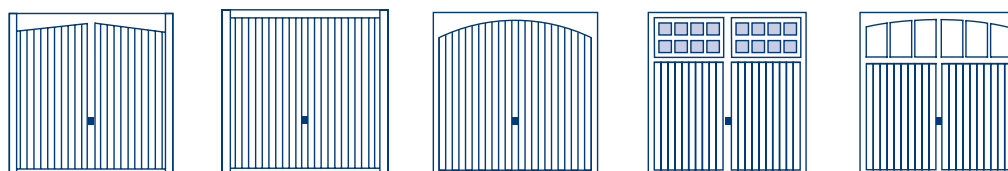

Nominal Door Size Width x Height (mm x mm)	Size Code	Barrington		Kingsbury		Adlington		Ashton ¹		Rochdale ¹	
		C	R	C	R	C	R	C	R	C	R
2134 x 1981	7066	3821	3872	3789	3840	3443	3494	4474	4525	4520	4571
2134 x 2136	7070	3845	3896	3819	3870	3443	3494	4545	4596	4552	4602
2134 x 2286	7076	-	4259	-	4222	-	3805	-	4798	-	4856
2259 x 1981	7566	3972	4023	3939	3990	3593	3643	4773	4824	4687	4737
2259 x 2136	7570	3997	4048	3969	4020	3615	3666	4796	4846	4709	4760
2284 x 1981	7666	3972	4023	3939	3990	3593	3643	4773	4824	4687	4737
2284 x 2136	7670	3997	4048	3969	4020	3615	3666	4796	4846	4709	4760
2284 x 2286	7676	-	4400	-	4368	-	3976	-	5032	-	4947
2439 x 1981	8066	4112	4162	4076	4127	3952	4003	4931	4981	4835	4886
2439 x 2136	8070	4139	4189	4106	4157	3952	4003	-	5009	-	4925
2439 x 2286	8076	-	4529	-	4489	-	4049	-	5166	-	5071
2744 x 1981	9066	-	4690	-	4533	-	4212	-	5498	-	5533
2744 x 2136	9070	-	4731	-	4571	-	4212	-	5576	-	5621
2744 x 2286	9076	-	5100	-	4947	-	4545	-	5763	-	5798
3049 x 1981	1066	-	5303	-	5147	-	4553	-	6172	-	6218
3049 x 2136	1070	-	5348	-	5189	-	4553	-	6221	-	6261

¹ Ashton and Rochdale doors may have cross bracing and / or locking rods behind the windows depending upon the size and gear type.

Timber Panel Doors

Single Door - Standard Size

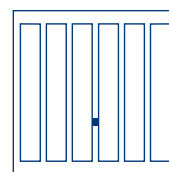
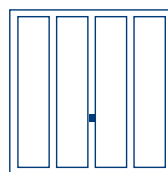
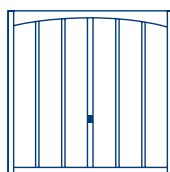
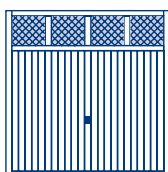

Nominal Door Size Width x Height (mm x mm)	Size Code	Sandhurst ¹		Shaftesbury		Grantham		Seymour	
		C	R	C	R	C	R	C	R
2134 x 1981	7066	4382	4433	3396	3447	2288	2339	3243	3294
2134 x 2136	7070	4409	4460	3415	3466	2288	2339	3274	3325
2134 x 2286	7076	-	4709	-	3675	-	2521	-	3521
2259 x 1981	7566	4544	4595	3462	3513	2435	2486	3313	3364
2259 x 2136	7570	4571	4622	3485	3535	2435	2486	3339	3390
2284 x 1981	7666	4544	4595	3462	3513	2435	2486	3313	3364
2284 x 2136	7670	4571	4622	3485	3535	2435	2486	3339	3390
2284 x 2286	7676	-	4806	-	3721	-	2695	-	3574
2439 x 1981	8066	4695	4746	3519	3570	2528	2578	3369	3420
2439 x 2136	8070	-	4783	3549	3600	2528	2578	3396	3447
2439 x 2286	8076	-	4929	-	3754	-	2802	-	3605
2744 x 1981	9066	-	5320	-	4259	-	2870	-	4077
2744 x 2136	9070	-	5407	-	4294	-	2870	-	4106
2744 x 2286	9076	-	5589	-	4494	-	3068	-	4277
3049 x 1981	1066	-	6003	-	4788	-	3118	-	4594
3049 x 2136	1070	-	6046	-	4833	-	3118	-	4597

¹ Sandhurst doors may have cross bracing and/or locking rods behind the windows depending upon the size and gear type.

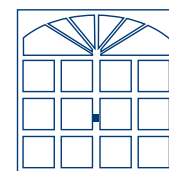
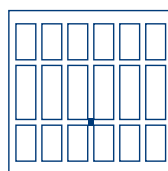
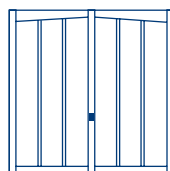
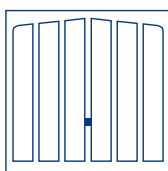

Nominal Door Size Width x Height (mm x mm)	Size Code	Tudor		Bosworth		Wolsey		Hinton ²	
		C	R	C	R	C	R	C	R
2134 x 1981	7066	3396	3447	3440	3491	3393	3444	4704	4755
2134 x 2136	7070	3415	3466	3463	3514	3413	3464	4733	4784
2134 x 2286	7076	-	3675	-	3718	-	3669	-	4989
2259 x 1981	7566	3462	3513	3508	3559	3459	3509	4999	5050
2259 x 2136	7570	3485	3535	3534	3585	3480	3531	5027	5078
2284 x 1981	7666	3462	3513	3508	3559	3459	3509	4999	5050
2284 x 2136	7670	3485	3535	3534	3585	3480	3531	5027	5078
2284 x 2286	7676	-	3721	-	3771	-	3719	-	5256
2439 x 1981	8066	3519	3570	3563	3614	3516	3567	5146	5197
2439 x 2136	8070	3549	3600	3586	3637	3540	3590	5179	5229
2439 x 2286	8076	-	3754	-	3801	-	3752	-	5381
2744 x 1981	9066	-	4259	-	4304	-	4153	-	5812
2744 x 2136	9070	-	4294	-	4333	-	4185	-	5843
2744 x 2286	9076	-	4494	-	4535	-	4355	-	6037
3049 x 1981	1066	-	4788	-	4833	-	4640	-	6566
3049 x 2136	1070	-	4833	-	4874	-	4644	-	6605

² Hinton doors may have cross bracing and/or locking rods behind the windows depending upon the size and gear type.
For further options please see page 44.



Timber Panel Doors

Single Door - Purpose Made

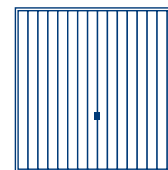
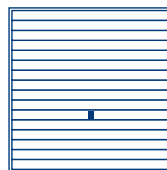
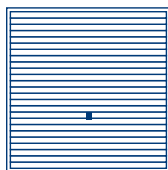
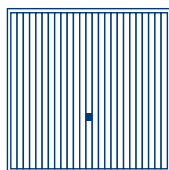

Nominal Door Size Width x Height (mm x mm)	Vertical Timber		Horizontal Timber		Countryman		Hampton	
	C	R	C	R	C	R	C	R
1930-1984 x 1931-1981 ²	3275	3326	3442	3493	4583	4634	4583	4634
1930-1984 x 1982-2136	3296	3347	3468	3519	4715	4765	4715	4765
1930-1984 x 2137-2286	-	3693	-	3879	-	5107	-	5107
1985-2284 x 1931-1981 ²	3424	3475	3603	3654	4829	4880	4829	4880
1985-2284 x 1982-2136	3451	3502	3630	3681	4980	5031	4980	5031
1985-2284 x 2137-2286	-	3821	-	4009	-	5363	-	5363
2285-2439 x 1931-1981 ²	3605 ¹	3656	3795 ¹	3846	4898	4949	4898	4949
2285-2439 x 1982-2136	3630 ¹	3681	3821 ¹	3872	5045	5096	5045	5096
2285-2439 x 2137-2286	-	4031	-	-	-	-	-	-
2440-2744 x 1931-1981 ²	-	4194	-	-	-	-	-	-
2440-2744 x 1982-2136	-	4222	-	-	-	-	-	-
2440-2744 x 2137-2286	-	4579	-	-	-	-	-	-
2745-3049 x 1931-1981 ²	-	4801	-	-	-	-	-	-
2745-3049 x 1982-2136	-	4851	-	-	-	-	-	-

¹ These doors are not available over 2438mm wide

² Retractable doors only available over 1946mm high

Orders for purpose made sizes will only be accepted as nominal door size for unframed version and overall frame size when ordering a framed version. Orders for purpose made framed doors will not be accepted as nominal door size.

For further options please see page 44.

Timber Panel Doors

Single Door - Purpose Made Size

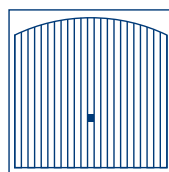
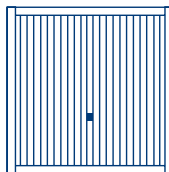
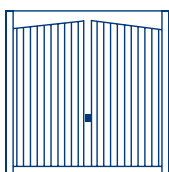

Nominal Door Size Width x Height (mm x mm)	Barrington		Kingsbury		Adlington		Ashton ²	
	C	R	C	R	C	R	C	R
1930-1984 x 1931-1981 ³	4142	4192	4113	4163	3534	3585	4809	4860
1930-1984 x 1982-2136	4165	4216	4141	4191	3558	3609	4835	4886
1930-1984 x 2137-2286	-	4583	-	4544	-	3952	-	5242
1985-2284 x 1931-1981 ³	4290	4341	4264	4315	3688	3739	4963	5014
1985-2284 x 1982-2136	4320	4371	4287	4338	3714	3765	4986	5036
1985-2284 x 2137-2286	-	4729	-	4690	-	4083	-	5387
2285-2439 x 1931-1981 ³	4430 ¹	4481	4397 ¹	4448	3867 ¹	3917	5096	5146
2285-2439 x 1982-2136	4454 ¹	4505	4427 ¹	4478	3893 ¹	3943	5126	5177
2285-2439 x 2137-2286	-	4853	-	4810	-	4294	-	5511
2440-2744 x 1931-1981 ³	-	5014	-	4858	-	4457	-	5555
2440-2744 x 1982-2136	-	5049	-	4894	-	4477	-	5589
2440-2744 x 2137-2286	-	5430	-	5272	-	4842	-	5969
2745-3049 x 1931-1981 ³	-	5626	-	5469	-	5064	-	6168
2745-3049 x 1982-2136	-	5675	-	5513	-	5107	-	6209

¹ These doors are not available over 2438mm wide

² Ashton doors may have cross bracing and / or locking rods behind the windows depending upon the size and gear type

³ Retractable doors only available over 1946mm high

Orders for purpose made sizes will only be accepted as nominal door size for unframed version and overall frame size when ordering a framed version. Orders for purpose made framed doors will not be accepted as nominal door size.

For further options please see page 44.

Timber Panel Doors

Single Door - Purpose Made Size

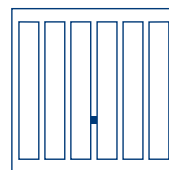
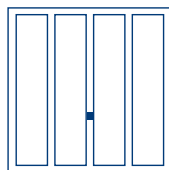
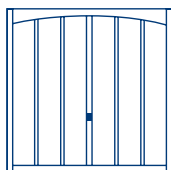

Nominal Door Size Width x Height (mm x mm)	Shaffesbury		Grantham		Seymour	
	C	R	C	R	C	R
1930-1984 x 1931-1981 ²	3566	3616	2993	3043	3566	3616
1930-1984 x 1982-2136	3593	3643	3020	3070	3593	3643
1930-1984 x 2137-2286	-	3845	-	3276	-	3845
1985-2284 x 1931-1981 ²	3632	3683	3063	3114	3632	3683
1985-2284 x 1982-2136	3663	3714	3092	3143	3663	3714
1985-2284 x 2137-2286	-	3898	-	3330	-	3898
2285-2439 x 1931-1981 ²	3693 ¹	3744	3124 ¹	3175	3693 ¹	3744
2285-2439 x 1982-2136	3718 ¹	3769	3146 ¹	3197	3718 ¹	3769
2285-2439 x 2137-2286	-	3929	-	3358	-	3929
2440-2744 x 1931-1981 ²	-	4397	-	3827	-	4397
2440-2744 x 1982-2136	-	4430	-	3861	-	4430
2440-2744 x 2137-2286	-	4599	-	4031	-	4599
2745-3049 x 1931-1981 ²	-	4920	-	4350	-	4920
2745-3049 x 1982-2136	-	4921	-	4351	-	4921

¹ These doors are not available over 2438mm wide

² Retractable doors only available over 1946mm high

Orders for purpose made sizes will only be accepted as nominal door size for unframed version and overall frame size when ordering a framed version. Orders for purpose made framed doors will not be accepted as nominal door size.

For further options please see page 44.

Timber Panel Doors

Single Door - Purpose Made Size

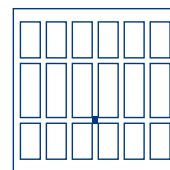
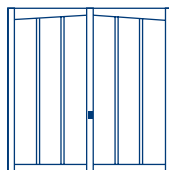
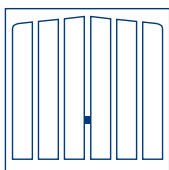

Nominal Door Size Width x Height (mm x mm)	Tudor		Bosworth		Wolsey	
	C	R	C	R	C	R
1930-1984 x 1931-1981 ²	3718	3769	3760	3810	3712	3763
1930-1984 x 1982-2136	3739	3790	3788	3839	3736	3787
1930-1984 x 2137-2286	-	3994	-	4040	-	3988
1985-2284 x 1931-1981 ²	3787	3837	3830	3881	3782	3833
1985-2284 x 1982-2136	3815	3866	3855	3906	3805	3856
1985-2284 x 2137-2286	-	4047	-	4095	-	4041
2285-2439 x 1931-1981 ²	3843 ¹	3894	3883 ¹	3934	3836 ¹	3887
2285-2439 x 1982-2136	3867 ¹	3917	3911 ¹	3962	3864 ¹	3915
2285-2439 x 2137-2286	-	4079	-	4118	-	4076
2440-2744 x 1931-1981 ²	-	4583	-	4623	-	4474
2440-2744 x 1982-2136	-	4613	-	4660	-	4507
2440-2744 x 2137-2286	-	4811	-	4861	-	4677
2745-3049 x 1931-1981 ²	-	5112	-	5158	-	4965
2745-3049 x 1982-2136	-	5158	-	5199	-	4968

¹ These doors are not available over 2438mm wide

² Retractable doors only available over 1946mm high

Orders for purpose made sizes will only be accepted as nominal door size for unframed version and overall frame size when ordering a framed version. Orders for purpose made framed doors will not be accepted as nominal door size.

For further options please see page 44.

Timber Panel Doors

Double Door - Standard Size

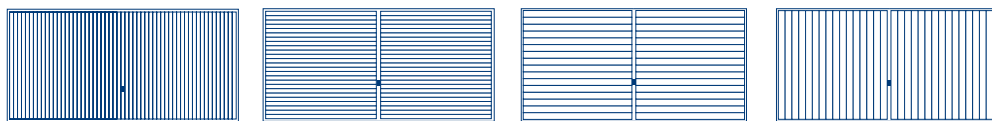

Nominal Door Size Width x Height (mm x mm)	Size Code	Vertical Timber		Horizontal Timber		Countryman		Hampton	
		R	R	R	R	R	R	R	R
3049 x 2286	1076	5188		5255		6716		6716	
3354 x 1981	1166	5188		5256		6648		6648	
3354 x 2136	1170	5333		5406		6790		6790	
3354 x 2286	1176	5767		5843		7363		7363	
3659 x 1981	1266	5846		5926		7399		7399	
3659 x 2136	1270	5998		6072		7542		7542	
3659 x 2286	1276	6525		6610		8237		8237	
3964 x 1981	1366	6910		7010		8152		8152	
3964 x 2136	1370	7129		7227		8373		8373	
3964 x 2286	1376	7736		7838		9104		9104	
4269 x 1981	1466	6762		6861		8397		8397	
4269 x 2136	1470	6910		7010		8542		8542	
4574 x 1981	1566	7636		7741		-		-	
4574 x 2136	1570	7854		7954		-		-	
4879 x 1981	1666	8327		8438		-		-	
4879 x 2136	1670	8398		8510		-		-	

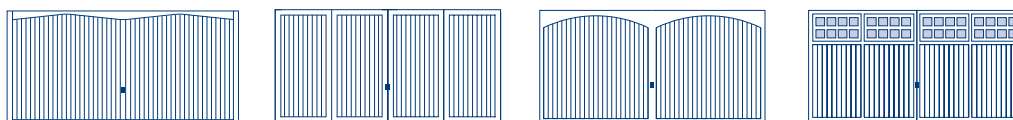

Nominal Door Size Width x Height (mm x mm)	Size Code	Barrington		Kingsbury		Adlington		Ashton ¹	
		R	R	R	R	R	R	R	R
3049 x 2286	1076	6171		5885		5763		6856	
3354 x 1981	1166	6124		5869		5653		6653	
3354 x 2136	1170	6270		6014		5792		6797	
3354 x 2286	1176	6797		6518		6278		7368	
3659 x 1981	1266	6819		6560		6259		7641	
3659 x 2136	1270	6965		6708		6401		7787	
3659 x 2286	1276	7602		7352		6980		8506	
3964 x 1981	1366	7933		7764		7576		8962	
3964 x 2136	1370	8152		7981		7796		9182	
3964 x 2286	1376	8861		8678		8473		9992	
4269 x 1981	1466	7787		7620		7432		8818	
4269 x 2136	1470	7933		7764		7576		8962	
4574 x 1981	1566	8655		8545		-		9717	
4574 x 2136	1570	8874		8763		-		9932	
4879 x 1981	1666	9346		9239		-		10521	
4879 x 2136	1670	9423		9313		-		10591	

¹ Ashton doors may have cross bracing and/or locking rods behind the windows depending upon the size and gear type.

For further options please see page 44.

Timber Panel Doors

Double Door - Standard Size

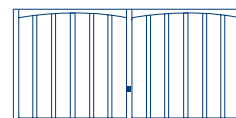
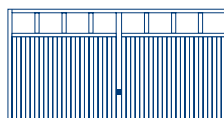

Nominal Door Size Width x Height (mm x mm)	Size Code	Rochdale ^{1,2}		Sandhurst ¹		Shaftesbury	
		R	R	R	R	R	R
3049 x 2286	1076	7251		6374		5011	
3354 x 1981	1166	7014		6333		4947	
3354 x 2136	1170	7161		6478		5092	
3354 x 2286	1176	7773		7027		5501	
3659 x 1981	1266	8002		7145		5491	
3659 x 2136	1270	8152		7291		5635	
3659 x 2286	1276	8904		7954		6133	
3964 x 1981	1366	9329		8338		6394	
3964 x 2136	1370	9549		8552		6611	
3964 x 2286	1376	10386		9307		7161	
4269 x 1981	1466	9182		8188		6249	
4269 x 2136	1470	9329		8338		6394	
4574 x 1981	1566	10392		9313		7161	
4574 x 2136	1570	10611		9534		7379	
4879 x 1981	1666	11102		10331		7961	
4879 x 2136	1670	11173		10409		8038	

¹ Rochdale and Sandhurst doors may have cross bracing and/or locking rods behind the windows depending upon the size and gear type.

² Rochdale doors up to 3659 mm wide will be manufactured with one arch not the two as shown above.

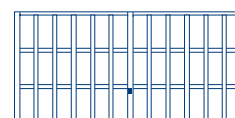
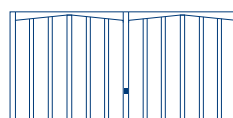
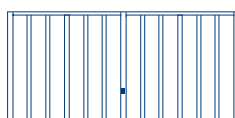
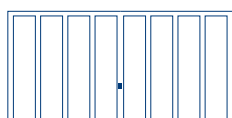

Nominal Door Size Width x Height (mm x mm)	Size Code	Grantham		Seymour		Tudor		Wolsey	
		R	R	R	R	R	R	R	R
3049 x 2286	1076	4387		4962		5011		5626	
3354 x 1981	1166	4295		4803		4947		5569	
3354 x 2136	1170	4440		4947		5092		5715	
3354 x 2286	1176	4784		5341		5501		6124	
3659 x 1981	1266	4856		5420		5491		6112	
3659 x 2136	1270	5002		5563		5635		6259	
3659 x 2286	1276	5435		6057		6133		6750	
3964 x 1981	1366	5435		6318		6394		7015	
3964 x 2136	1370	5653		6538		6611		7234	
3964 x 2286	1376	6102		7086		7161		7781	
4269 x 1981	1466	5288		6171		6249		6869	
4269 x 2136	1470	5435		6318		6394		7015	
4574 x 1981	1566	-		-		7161		7781	
4574 x 2136	1570	-		-		7379		7998	
4879 x 1981	1666	-		-		7961		8585	
4879 x 2136	1670	-		-		8038		8655	

For further options please see page 44.

Timber Panel Doors

Double Door - Purpose Made Size

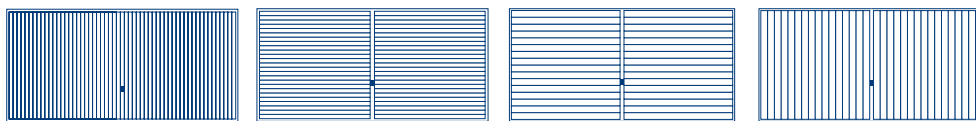

Nominal Door Size Width x Height (mm x mm)	Vertical Timber		Horizontal Timber		Countryman	Hampton
	R	R	R	R	R	R
2745-3049 x 2137-2286	-	-	-	-	-	-
3050-3659 x 1931-1981	6430	6518	7893	7893		
3050-3659 x 1982-2136	6590	6678	8050	8050		
3050-3659 x 2137-2286	7175	7272	8794	8794		
3660-4269 x 1931-1981	7838	7949	9349	9349		
3660-4269 x 1982-2136	8085	8188	9589	9589		
3660-4269 x 2137-2286	8487	8600	10069	10069		
4270-5000 x 1931-1981	9161	9279	-	-		
4270-5000 x 1982-2136	9239	9359	-	-		

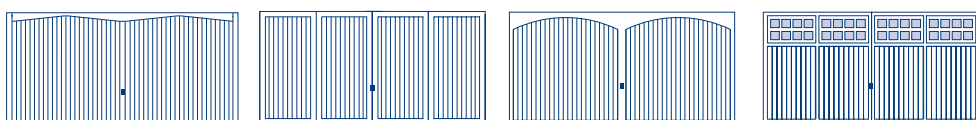

Nominal Door Size Width x Height (mm x mm)	Barrington		Kingsbury		Adlington	Ashton ¹
	R	R	R	R	R	R
2745-3049 x 2137-2286	-	-	-	-	-	7533
3050-3659 x 1931-1981	7497	7219	6877	8402		
3050-3659 x 1982-2136	7658	7379	7039	8564		
3050-3659 x 2137-2286	8359	8085	7672	9349		
3660-4269 x 1931-1981	8966	8787	8577	10099		
3660-4269 x 1982-2136	9207	9024	8817	10337		
3660-4269 x 2137-2286	9667	9471	9256	10853		
4270-5000 x 1931-1981	10282	10164	-	11565		
4270-5000 x 1982-2136	10367	10242	-	11645		

¹ Ashton doors may have cross bracing and/or locking rods behind the windows depending upon the size and gear type.

Orders for purpose made sizes will only be accepted as nominal door size for unframed version and overall frame size when ordering a framed version. Orders for purpose made framed doors will not be accepted as nominal door size.

For further options please see page 44.

Timber Panel Doors

Double Door - Purpose Made Size

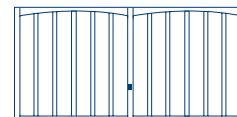
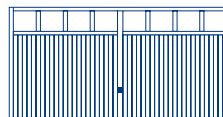

Nominal Door Size Width x Height (mm x mm)	Rochdale ^{1, 2}		Sandhurst ¹		Shaftesbury	
		R		R		R
2745-3049	x	2137-2286	7976	7010	5502	
2745-3049	x	2287-2439	8381	7359	5784	
3050-3659	x	1931-1981	8805	7860	6037	
3050-3659	x	1982-2136	8966	8021	6197	
3050-3659	x	2137-2286	9792	8749	6745	
3050-3659	x	2287-2439	10277	9185	7080	
3660-4269	x	1931-1981	10501	9408	7273	
3660-4269	x	1982-2136	10741	9648	7515	
3660-4269	x	2137-2286	11277	10129	7892	
3660-4269	x	2287-2439	11813	10611	8262	
4270-5000	x	1931-1981	12211	11367	8757	
4270-5000	x	1982-2136	12289	11446	8840	

¹ Rochdale and Sandhurst doors may have cross bracing and/or locking rods behind the windows depending upon the size and gear type.

² Rochdale doors up to 3659 mm wide will be manufactured with one arch not the two as shown above.

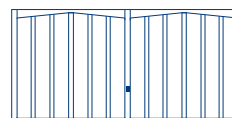
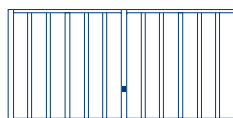
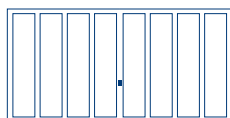

Nominal Door Size Width x Height (mm x mm)	Grantham		Seymour		Tudor		Wolsey	
		R		R		R		R
2745-3049	x	2137-2286	4823	5457	5502		6125	
2745-3049	x	2287-2439	5065	5731	5784		6402	
3050-3659	x	1931-1981	5334	5956	6037		6658	
3050-3659	x	1982-2136	5499	6117	6197		6819	
3050-3659	x	2137-2286	5972	6664	6745		7363	
3050-3659	x	2287-2439	6270	6996	7080		7695	
3660-4269	x	1931-1981	6212	7190	7273		7895	
3660-4269	x	1982-2136	6452	7435	7515		8131	
3660-4269	x	2137-2286	6779	7805	7892		8510	
3660-4269	x	2287-2439	7101	8177	8262		8884	
4270-5000	x	1931-1981	-	-	8757		9377	
4270-5000	x	1982-2136	-	-	8840		9456	

Orders for purpose made sizes will only be accepted as nominal door size for unframed version and overall frame size when ordering a framed version. Orders for purpose made framed doors will not be accepted as nominal door size.

For further options please see page 44.

Timber Panel Doors

Timber door window options



	Standard		Georgian ¹		Diagonal ¹	
	Single doors	Double doors	Single doors	Double doors	Single doors	Double doors
Plain	no on-cost	no on-cost	183	252	183	252
Crystal	no on-cost	no on-cost	183	252	183	252

¹ Only available on Sandhurst.

Windows are manufactured from 4 mm acrylic panes. Please state on order if clear or stippled panes required.

Options

	Single doors add	Double doors add
Factory pre-framed standard single doors	191	-
Steel frame for standard double doors	-	286
Factory pre-framed purpose-made single doors	216	-
Steel frame for purpose-made double doors	-	318
Additional Lock Kit, C-type/ R-type (fitted onto door)	89	-
Factory fully finished stain in Light Oak, Antique Oak, Mahogany, Walnut, Chestnut and Ebony	248	367
White primer ready for on-site painting on retractable gear only and up to 2439mm wide x 2136mm high	336	513
Fully finished painting on retractable gear only and up to 2439mm wide x 2136mm high (any RAL colour timber only)	555	962
Diecast metal handles with matching base plates: brass effect, chrome effect, brushed steel and white	133	133
Bottom weatherseal, 2405 mm length (suitable for gaps up to 15 mm between the door and the floor level)	65	65
Bottom weatherseal, 3000 mm length (suitable for gaps up to 15 mm between the door and the floor level)	73	73
Surcharge for colour steel Chassis and/or frame finished in RAL colour (no additional charge for Brown RAL8028 or White RAL9016 chassis and frame)	189	295

Please note, retractable plus lifting gear is not available on timber up and over garage doors.

Steel and Timber Garage Side Doors

Surface

Steel doors constructed around a strong steel box section chassis in Traffic White (RAL 9016) as standard. Timber doors constructed using timber, built around a strong steel box section chassis. A range of stain options are available.

Handle

Supplied with lever/lever handle on left side (viewed outside)

Terminology

Nominal Door Size: This is the actual door panel size plus the fitting tolerances. The nominal door size should be used for internal dimensions of a timber frame.

Size Code: This has traditionally been used to order doors. This may not be the actual door size.

All doors come factory pre-framed, right hand hinged with the handle on the left as standard (viewed from outside). Supplied with lever/lever handle set. Doors only available to open outwards.

Steel and Timber Garage Side Doors

Steel door - standard sizes

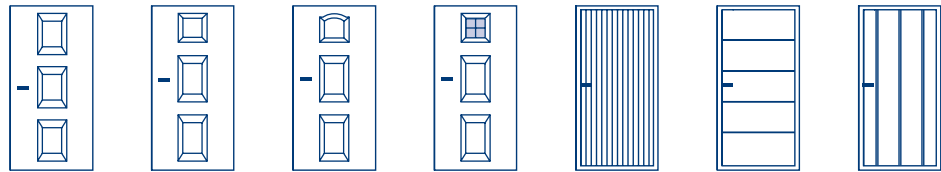

Nominal Door Size Width x Height (mm x mm)	Overall frame size (between fix) ¹ Width x Height (mm x mm)	Size Code							
			Georgian	Beaumont	Cathedral	Beaumont with Windows ²	Carlton	Ascot	Windsor
732 x 1905	882 x 1991	2664	1170	1170	1170	1290	968	1170	1170
732 x 1955	882 x 2041	2666	1193	1193	1193	1310	988	1193	1193
732 x 2110	882 x 2196	2670	1222	1222	1222	1341	1016	1222	1222
884 x 1905	1034 x 1991	3064	1211	1211	1211	1331	1006	1211	1211
884 x 1955	1034 x 2041	3066	1234	1234	1234	1349	1029	1234	1234
884 x 2110	1034 x 2196	3070	1265	1265	1265	1385	1061	1265	1265
1037 x 1905	1187 x 1991	3664	1253	1253	1253	1373	1047	1253	1253
1037 x 1955	1187 x 2041	3666	1277	1277	1277	1392	1071	1277	1277
1037 x 2110	1187 x 2196	3670	1303	1303	1303	1424	1099	1303	1303
1170 x 1905	1320 x 1991	4064	1294 ³	1294 ³	1294 ³	1410 ³	1088	1294	1294
1170 x 1955	1320 x 2041	4066	1313 ³	1313 ³	1313 ³	1433 ³	1112	1313	1313
1170 x 2110	1320 x 2196	4070	1328 ³	1328 ³	1328 ³	1445 ³	1138	1328	1328

¹ No fitting clearance allowed.

² Windows for Beaumont: Standard (□), Diamond (◊), Cross (⊕). Please state on order if plain or crystal panes.

³ Purpose made Georgian, Beaumont and Cathedral models have two panel pressings on door design when overall frame width is over 1210mm

Steel door - purpose-made sizes

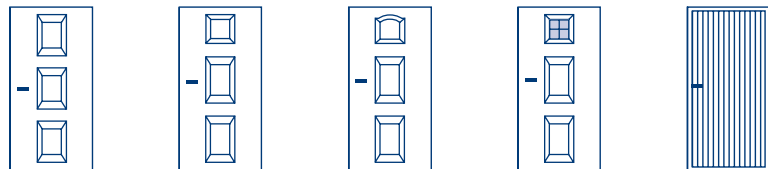

Nominal Door Size Width x Height (mm x mm)	Overall frame size (between fix) ¹ Width x Height (mm x mm)					
		Georgian ³	Beaumont ³	Cathedral ³	Beaumont with Windows ^{2,3}	Carlton
670-1036 x 1905-2110	820-1186 x 1991-2196	1457 ⁴	1457 ⁴	1457 ⁴	1624 ⁴	1277
1037-1310 x 1905-2110	1187-1320 x 1991-2196	1540	1540	1540	1704	1354

¹ No fitting clearance allowed.

² Windows for Beaumont: Standard (□), Diamond (◊), Cross (⊕). Please state on order if plain or crystal panes.

³ Purpose-made Georgian, Beaumont and Cathedral models have two panel pressings on door design when overall frame width is over 1210 mm.

⁴ Georgian, Beaumont, Cathedral available minimum overall frame size 882mm

For further options please see page 55.

Steel and Timber Garage Side Doors

Timber door - standard sizes

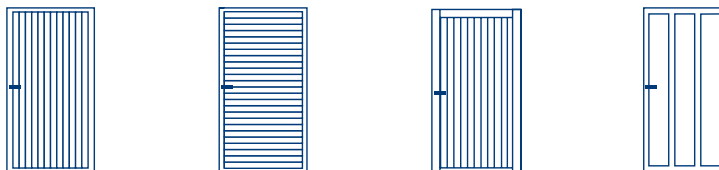

Nominal Door Size Width x Height (mm x mm)	Overall frame size (between fix) ¹ Width x Height (mm x mm)	Size Code	Vertical Timber	Horizontal Timber	Kingsbury	Seymour
732 x 1905	882 x 1991	2664	2837	2905	3084	2837
732 x 1955	882 x 2041	2666	2874	2941	3114	2874
732 x 2110	882 x 2196	2670	2925	2984	3159	2925
884 x 1905	1034 x 1991	3064	2941	3002	3174	2941
884 x 1955	1034 x 2041	3066	2970	3032	3209	2970
884 x 2110	1034 x 2196	3070	3017	3084	3252	3017
1037 x 1905	1187 x 1991	3664	3032	3095	3276	3032
1037 x 1955	1187 x 2041	3666	3063	3131	3303	3063
1037 x 2110	1187 x 2196	3670	3114	3174	3350	3114
1170 x 1905	1320 x 1991	4064	3131	3190	3364	3131
1170 x 1955	1320 x 2041	4066	3159	3226	3400	3159
1170 x 2110	1320 x 2196	4070	3209	3276	3440	3209

¹ No fitting clearance allowed.

Timber door - purpose-made sizes

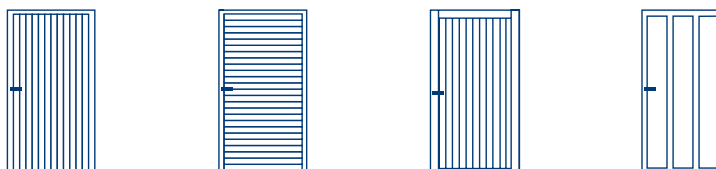

Nominal Door Size Width x Height (mm x mm)	Overall frame size (between fix) ¹ Width x Height (mm x mm)	Vertical Timber	Horizontal Timber	Kingsbury ²	Seymour
670-1036 x 1905-2110	820-1186 x 1991-2196	3429	3495	3665	3429
1037-1310 x 1905-2110	1187-1320 x 1991-2196	3618	3682	3851	3618

¹ No fitting clearance allowed.

² Minimum overall frame width for Kingsbury is 826 mm.

For further options please see page 55.

Steel and Timber Side-hinged Doors

Surface

Steel Side-hinged doors are constructed around a strong steel box section chassis in Traffic White (RAL 9016) as standard. Timber doors constructed using timber, built around our steel box section chassis. A range of stain options are available.

Pre-Framed Design and Concealed Hinges

All doors come factory pre-framed with 75mm wide door frame and right-hand door leaf leading as standard. Hinges are concealed in the frame, with no hinge knuckles protruding above the surface of the door.

Two-Point Locking

A shoot bolt latch is used to secure the fixed door leaf at the top and bottom.

Door Stays and Gas Piston

Supplied complete with solid metal door stays and pull cord release. Gas pistons are fitted to each door leaf for a controlled closing motion.

Rubber weather seals

Sturdy rubber weather seals all built into the door frame and along the door stop on the fixed and leading door leaf.

Aluminium threshold

A 20 mm aluminium threshold is supplied as standard at the base of the door.

Steel Colours

Standard colours are:

- Traffic White (RAL 9016)

Optional colours available:

- | | | |
|--------------------------|------------------------------|-----------------------------|
| • Light Ivory (RAL 1015) | • Fir Green (RAL 6009) | • Window Grey (RAL 7040) |
| • Ruby Red (RAL 3003) | • Slate Grey (RAL 7015) | • Terra Brown (RAL 8028) |
| • Signal Blue (RAL 5005) | • Anthracite Grey (RAL 7016) | • Jet Black (RAL 9005) |
| • Steel Blue (RAL 5011) | • Stone Grey (RAL 7030) | • Bergundy Brown |
| • Pigeon Blue (RAL 5014) | • Light grey (RAL 7035) | • Golden Brown |
| • Moss Green (RAL 6005) | • Agate Grey (RAL 7038) | • Chartwell Green (BS 4800) |

Timber Stains

Full finished stains available as an option. Stain colours include Light Oak, Antique Oak, Mahogany, Walnut, Chestnut and Ebony

Steel and Timber Side-hinged Doors

Handle

Supplied with black lever/ lever handle on right side (viewed outside) and centrally located flip-up handle which releases shoot-bolt latches at the top and bottom of the fixed leaf (viewed inside).

Terminology

Nominal Door Size: This is the actual door panel size plus the fitting tolerances. The nominal door size should be used for internal dimensions of a timber frame..

Size Code: This has traditionally been used to order doors. This may not be the actual door size.

Packaging

All doors are supplied wrapped. Only steel doors are supplied unwrapped as standard with optional poly-wrapping available.

Steel door - standard sizes

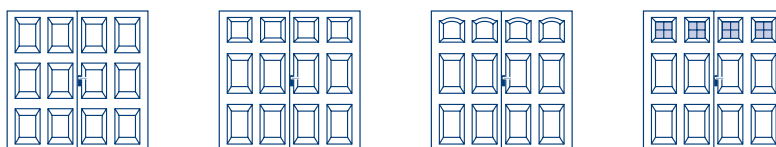

Nominal Door Size Width x Height (mm x mm)	Overall frame size (between fix) ¹ Width x Height (mm x mm)	Size Code				
			Georgian	Beaumont	Cathedral	Beaumont with Windows ²
1780 x 1806	1930 x 1891	6060	-	-	-	-
1934 x 1806	2084 x 1891	6660	-	-	-	-
1934 x 1907	2084 x 1991	6664	-	-	-	-
1934 x 1957	2084 x 2041	6666	-	-	-	-
1934 x 2112	2084 x 2196	6670	-	-	-	-
2084 x 1806	2234 x 1891	7060	-	-	-	-
2084 x 1907	2234 x 1991	7064	2304	2304	2304	2753
2084 x 1957	2234 x 2041	7066	2304	2304	2304	2753
2084 x 2112	2234 x 2196	7070	2339	2339	2339	2789
2209 x 1907	2359 x 1991	7564	2410	2410	2410	2862
2209 x 1957	2359 x 2041	7566	2410	2410	2410	2862
2209 x 2112	2359 x 2196	7570	2449	2449	2449	2897
2234 x 1907	2384 x 1991	7664	2449	2449	2449	2897
2234 x 1957	2384 x 2041	7666	2449	2449	2449	2897
2234 x 2112	2384 x 2196	7670	2481	2481	2481	2930
2389 x 1907	2539 x 1991	8064	2556	2556	2556	3004
2389 x 1957	2539 x 2041	8066	2556	2556	2556	3004
2389 x 2112	2539 x 2196	8070	2587	2587	2587	3037

¹ No fitting clearance allowed.

² Windows for Beaumont: Standard (□), Diamond (◊), Cross (⊕). Please state on order if plain or crystal panes.

Steel and Timber Side-hinged Doors

Steel door - standard sizes



Nominal Door Size Width x Height (mm x mm)	Overall frame size (between fix) ¹ Width x Height (mm x mm)	Size Code					
			Carlton	Ascot	Windsor	Salisbury Version 1	Salisbury Version 2
1780 x 1806	1930 x 1891	6060	2025	-	-	-	-
1934 x 1806	2084 x 1891	6660	2058	-	-	-	-
1934 x 1907	2084 x 1991	6664	2094	-	-	-	-
1934 x 1957	2084 x 2041	6666	2094	-	-	-	-
1934 x 2112	2084 x 2196	6670	2133	-	-	-	-
2084 x 1806	2234 x 1891	7060	2133	-	-	-	-
2084 x 1907	2234 x 1991	7064	2166	2304	2304	-	-
2084 x 1957	2234 x 2041	7066	2166 ³	2304	2304	3053	-
2084 x 2112	2234 x 2196	7070	2202 ³	2339	2339	3053	-
2209 x 1907	2359 x 1991	7564	2273	2410	2410	-	-
2209 x 1957	2359 x 2041	7566	2273	2410	2410	-	-
2209 x 2112	2359 x 2196	7570	2304	2449	2449	-	-
2234 x 1907	2384 x 1991	7664	2304	2449	2449	-	-
2234 x 1957	2384 x 2041	7666	2304	2449	2449	-	3115
2234 x 2112	2384 x 2196	7670	2339	2481	2481	-	3115
2389 x 1907	2539 x 1991	8064	2410	2556	2556	-	-
2389 x 1957	2539 x 2041	8066	2410	2556	2556	-	3115
2389 x 2112	2539 x 2196	8070	2449	2587	2587	-	3115

¹ No fitting clearance allowed.

² Windows for Beaumont: Standard (□), Diamond (◊), Cross (⊕). Please state on order if plain or crystal panes.

³ Carlton 7066 and 7070 stock door only available as Traffic White (RAL 9016) with right hand leading

All doors come factory pre-framed, right hand door leaf leading as standard (viewed from the outside) with lever/lever handle set.

Ascot, Windsor and Salisbury side-hinged garage doors are only available in 50/ 50 door leaf configuration.

The above doors are shown as 50/50 door leaves configuration. Up to 2234 mm overall frame width these doors are also available as a 1/3 2/3 door configuration. Prices are the same but please be aware panel configurations on Georgian, Beaumont & Cathedral doors will have 3 pressing columns with increased spacing between the pressing (1/3 2/3 is a term used to describe these doors but please note the 1/3 door leaf is always 800 mm wide with the 2/3 element varying to make the desired overall width). 1/3 leaf is always leading

Carlton doors are available as a 1/3, 2/3 option in overall frame sizes up to 2234 mm wide. Georgian, Beaumont, Cathedral and Beaumont with windows doors are available as a 1/3, 2/3 option only in one overall frame width, 2234 mm wide.

Steel and Timber Side-hinged Doors

Steel door - purpose-made sizes

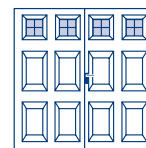
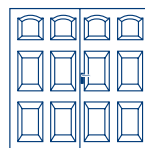
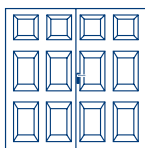
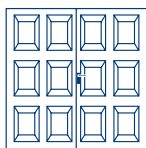

Overall frame size (between fix) ¹ Width x Height (mm x mm)		Georgian	Beaumont	Cathedral	Beaumont with Windows ²
2234 - 2384	x 1991 - 2041	2569	2569	2569	3124
2234 - 2384	x 2042 - 2196	2595	2595	2595	3150
2385 - 2539	x 1891 - 1990	-	-	-	-
2385 - 2539	x 1991 - 2041	2712	2712	2712	3261
2385 - 2539	x 2042 - 2196	2740	2740	2740	3296

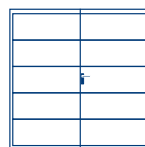
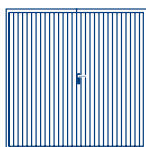

Overall frame size (between fix) ¹ Width x Height (mm x mm)		Carlton	Ascot
1930 - 2233	x 1891 - 2041	2292	-
1930 - 2233	x 2042 - 2196	2350	-
2234 - 2384	x 1891 - 1990	2377	-
2234 - 2384	x 1991 - 2041	2449	2569
2234 - 2384	x 2042 - 2196	2493	2595
2385 - 2539	x 1891 - 1990	2474	-
2385 - 2539	x 1991 - 2041	2566	2712
2385 - 2539	x 2042 - 2196	2597	2740

¹ No fitting clearance allowed.

² Windows for Beaumont: Standard () , Diamond () , Cross () . Please state on order if plain or crystal panes.

All doors come factory pre-framed, right hand door leaf leading as standard (viewed from the outside) with lever/lever handle set.

Ascot and Windsor side-hinged garage doors are only available in 50/ 50 door leaf configuration.

The above doors are shown as 50/50 door leaves configuration. Up to 2234 mm overall frame width these doors are also available as a 1/3 2/3 door configuration. Prices are the same but please be aware panel configurations on Georgian, Beaumont & Cathedral doors will have 3 pressing columns with increased spacing between the pressing (1/3 2/3 is a term used to describe these doors but please note the 1/3 door leaf is always 800 mm wide with the 2/3 element varying to make the desired overall width). 1/3 leaf is always leading.

Carlton doors are available as a 1/3, 2/3 option in overall frame sizes up to 2234 mm wide. Georgian, Beaumont, Cathedral and Beaumont with windows doors are available as a 1/3, 2/3 option only in one overall frame width, 2234 mm wide.

For further options please see page 55.

Steel and Timber Side-hinged Doors

Timber door - standard sizes

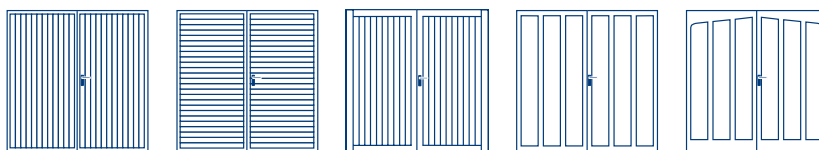

Nominal Door Size Width x Height (mm x mm)	Overall frame size (between fix) ¹ Width x Height (mm x mm)	Size Code	Vertical Timber ²	Horizontal Timber ²	Kingsbury ³	Seymour ³	Tudor ³
1780 x 1806	1930 x 1891	6060	4654	4747	5189	4417	4417
1934 x 1806	2084 x 1891	6660	4713	4810	5189	4476	4476
1934 x 1907	2084 x 1991	6664	4713	4810	5189	4476	4476
1934 x 1957	2084 x 2041	6666	4756	4855	5205	4520	4520
1934 x 2112	2084 x 2196	6670	4756	4855	5265	4520	4520
2084 x 1806	2234 x 1891	7060	4833	4928	5265	4595	4595
2084 x 1907	2234 x 1991	7064	4848	4944	5301	4611	4611
2084 x 1957	2234 x 2041	7066	4865	4959	5363	4622	4622
2084 x 2112	2234 x 2196	7070	4865	4959	5394	4622	4622
2209 x 1907	2359 x 1991	7564	4905	5005	5556	4675	4675
2209 x 1957	2359 x 2041	7566	4918	5021	5590	4687	4687
2209 x 2112	2359 x 2196	7570	4949	5043	5690	4713	4713
2234 x 1907	2384 x 1991	7664	4905	5005	5574	4675	4675
2234 x 1957	2384 x 2041	7666	4918	5021	5643	4687	4687
2234 x 2112	2384 x 2196	7670	4949	5044	5753	4713	4713
2389 x 1907	2539 x 1991	8064	5099	5195	6076	4865	4865
2389 x 1957	2539 x 2041	8066	5111	5211	6107	4879	4879
2389 x 2112	2539 x 2196	8070	5131	5220	6267	4890	4890

¹ No fitting clearance allowed.

² The above doors are shown as 50/50 door leaves configuration. Up to 2234 mm overall frame width these doors are also available as a 1/3 2/3 door configuration on Vertical Timber and Horizontal Timber doors.

Prices are the same but please be aware panel configurations may be different from those shown above (1/3 2/3 is a term used to describe these doors but please note the 1/3 door leaf is always 800 mm wide with the 2/3 element varying to make the desired overall width). 1/3 leaf is always leading.

³ Not available in 70/30 configuration. Only Vertical Timber and Horizontal Timber Side Hinged doors are available in 70/30 configuration up to 7'0" wide.

For further options please see page 55.

Steel and Timber Side-hinged Doors

Timber door - standard sizes

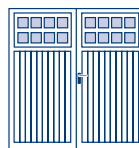
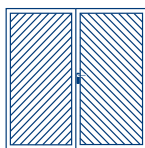

Nominal Door Size Width x Height (mm x mm)	Overall frame size (between fix) ¹ Width x Height (mm x mm)	Size Code	Chevron Timber ³	Ashton ^{3, 4}	Ashton Chevron ^{3, 4}
1780 x 1806	1930 x 1891	6060	5189	5574	5823
1934 x 1806	2084 x 1891	6660	5189	5574	5823
1934 x 1907	2084 x 1991	6664	5189	5574	5823
1934 x 1957	2084 x 2041	6666	5205	5590	5834
1934 x 2112	2084 x 2196	6670	5265	5643	5898
2084 x 1806	2234 x 1891	7060	5265	5643	5898
2084 x 1907	2234 x 1991	7064	5301	5690	5942
2084 x 1957	2234 x 2041	7066	5363	5753	6000
2084 x 2112	2234 x 2196	7070	5394	5776	6032
2209 x 1907	2359 x 1991	7564	5556	5942	6191
2209 x 1957	2359 x 2041	7566	5590	5969	6225
2209 x 2112	2359 x 2196	7570	5690	6076	6328
2234 x 1907	2384 x 1991	7664	5574	5955	6209
2234 x 1957	2384 x 2041	7666	5643	6032	6281
2234 x 2112	2384 x 2196	7670	5753	6129	6389
2389 x 1907	2539 x 1991	8064	6076	6458	6713
2389 x 1957	2539 x 2041	8066	6107	5982	6745
2389 x 2112	2539 x 2196	8070	6267	6652	6902

¹ No fitting clearance allowed.

² The above doors are shown as 50/50 door leaves configuration. Up to 2234 mm overall frame width these doors are also available as a 1/3 2/3 door configuration on Vertical Timber and Horizontal Timber doors.

Prices are the same but please be aware panel configurations may be different from those shown above (1/3 2/3 is a term used to describe these doors but please note the 1/3 door leaf is always 800 mm wide with the 2/3 element varying to make the desired overall width). 1/3 leaf is always leading.

³ Not available in 70/30 configuration. Only Vertical Timber and Horizontal Timber Side Hinged doors are available in 70/30 configuration up to 7'0" wide.

⁴ On doors with windows, please state on order if plain or crystal panes.

Timber door - purpose-made sizes

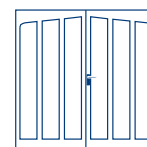
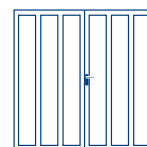
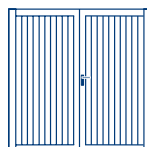
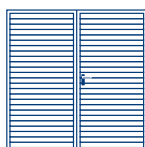
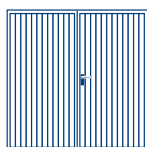

Overall frame size (between fix) ¹ Width x Height (mm x mm)		Vertical Timber ²	Horizontal Timber ²	Kingsbury ³	Seymour ³	Tudor ³	
1930 - 2233	x	1891 - 2041	4947	5044	5455	4729	4729
1930 - 2233	x	2042 - 2196	5044	5144	5555	4828	4828
2234 - 2384	x	1891 - 2041	5140	5243	5658	4929	4929
2234 - 2384	x	2042 - 2196	5278	5377	6048	5063	5063
2385 - 2539	x	1891 - 2041	5555	5658	6337	5339	5339
2385 - 2539	x	2042 - 2196	5640	5747	6440	5423	5423

¹ No fitting clearance allowed.

² On doors with windows, please state on order if plain or crystal panes.

Steel and Timber Side-hinged Doors

Timber door - purpose-made sizes

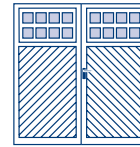
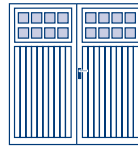
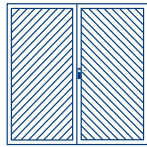

Overall frame size (between fix) ¹ Width x Height (mm x mm)		Chevron Timber ³	Ashton ^{3,4}	Ashton Chevron ^{3,4}	
1930 - 2233	x	1891 - 2041	5455	5829	6077
1930 - 2233	x	2042 - 2196	5555	5936	6179
2234 - 2384	x	1891 - 2041	5658	6034	6281
2234 - 2384	x	2042 - 2196	6048	6446	7867
2385 - 2539	x	1891 - 2041	6337	6736	6996
2385 - 2539	x	2042 - 2196	6440	6826	7089

¹ No fitting clearance allowed.

² The above doors are shown as 50/50 door leaves configuration. Up to 2234 mm overall frame width these doors are also available as a 1/3 2/3 door configuration on Vertical Timber and Horizontal Timber doors.

Prices are the same but please be aware panel configurations may be different from those shown above (1/3 2/3 is a term used to describe these doors but please note the 1/3 door leaf is always 800 mm wide with the 2/3 element varying to make the desired overall width). 1/3 leaf is always leading.

³ Not available in 70/30 configuration. Only Vertical Timber and Horizontal Timber Side Hinged doors are available in 70/30 configuration up to 7'0" wide.

⁴ On doors with windows, please state on order if plain or crystal panes.

Steel and Timber Side-hinged Doors

Options				
	Steel		Timber	
	Garage side doors	Side-hinged doors	Garage side doors	Side-hinged doors
For powder-coated steel doors:				
• Moss Green (RAL 6005)				
• Ruby Red (RAL 3003)				
• Signal Blue (RAL 5005)				
• Jet Black (RAL 9005)				
• Steel Blue (RAL 5011)				
• Light Ivory (RAL 1015)				
• Pigeon Blue (RAL 5014)				
• Fir Green (RAL 6009)				
• Anthracite Grey (RAL 7016)	145	189	-	-
• Stone Grey (RAL 7030)				
• Light Grey (RAL 7035)				
• Slate Grey (RAL 7015)				
• Agate Grey (RAL 7038)				
• Window Grey (RAL 7040)				
• Chartwell Green (BS 4800)				
• Burgundy Brown				
• Golden Brown				
• Terra Brown (RAL 8028)				
Colour matched windows for Salisbury side-hinged doors	-	237	-	-
Black window panes for Salisbury doors (price per door)	-	54	-	-
Coloured window frames to match door colour – Beaumont doors (price per window). Beaumont doors up to 2539 mm wide = 4 windows.	70 each	70 each	-	-
Surcharge for Premium GRP colours:				
• Green	-	-	-	-
• Blue	-	-	-	-
Handles for steel and timber doors:				
• knob/lever black plastic	48	48	48	48
For timber doors: factory fully finished in				
• Light Oak				
• Antique Oak				
• Mahogany	-	-	201	305
• Walnut				
• Chestnut				
• Ebony				
Factory white primer ready for on-site painting	-	-	305	375
Factory fully finished painting (any RAL colour)	-	-	504	626
Anodised Aluminium lever/lever handles:				
• white	177	177	177	177
Anodised Aluminium lever/lever handles:				
• chrome effect	222	222	222	222
Left hand leading	130	130	130	130
Fitting compensation kit (part no. 8261)	197	197	197	197
Poly-wrapping	51	51	-	-

¹ Coloured Beaumont with windows doors are supplied with white window frames as standard.

² Only available on steel side-hinged doors.

³ Colour match windows not available in Burgundy Brown or Golden Brown.

Chassis and frame will be Terra Brown (RAL 8028) except when the door is ebony when chassis/frame will be black (RAL 9005) or the door is white and the chassis/frame will be RAL 9016. To select an alternative colour chassis/frame from the options there is a charge of £189.

GRP Side-hinged Doors

GRP - side-hinged sizes

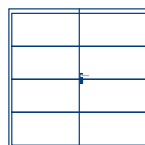
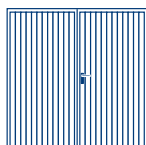

Overall Frame Size	Size Code	Somerset	Beaminster	Betchworth
2084 x 1891	6660	2906	2906	-
2084 x 1991	6664	2906	2906	-
2084 x 2041	6666	2906	2906	-
2084 x 2196	6670	2989	2989	-
2234 x 1891	7060	2906	2906	-
2234 x 1991	7064	2906	2906	2906
2234 x 2041	7066	2906	2906	2906
2234 x 2196	7070	2989	2989	2989
2359 x 1991	7564	3114	3114	3114
2359 x 2041	7566	3114	3114	3114
2359 x 2196	7570	3207	3207	3207
2384 x 1991	7664	3207	3207	3207
2384 x 2041	7666	3207	3207	3207
2384 x 2196	7670	3207	3207	3207
2539 x 1991	8064	3270	3270	3270
2539 x 2041	8066	3270	3270	3270
2539 x 2196	8070	3399	3399	3399

Chrome effect handle as standard, white or black on request - no additional cost

The Beaminster & Somerset purpose made size range is 1930mm to 2539mm wide x 1890mm to 2196mm high

The Betchworth is available 2234mm x 2539mm wide x 1980mm to 2196mm high

Woodgrain finish colour options available on Somerset and Betchworth: Magnolia, White, Light Oak, Irish Oak, Teak, Honey Beach, Red Mahogany, Ebony, Dark Mahogany, Ebony, Dark Mahogany, Anthracite Grey, Bleach Oak, Golden Brown, Dark Oak

Contemporary Finish Options available on Beaminster: White, Anthracite Grey, Black

Door Stays and Dampeners as standard

Betchworth supplied with Black Imitation windows as standard

Purpose made - next size up plus	156
Left hand leading	130
Window options (Clear Perspex, Stippled Perspex)	581
RAL Colours (British Standard Colours)	476
Additional frame colour which is not White, Black or Anthracite Grey	189

Garage Side Doors & Side-hinged Doors – Specifications

Door leaves supplied factory pre-framed ready for site installation. Fixed leaf (RH side when viewed from inside) fitted with tower bolts at top and bottom of inner leading edge. The floor will need to be finished and level for the bottom tower bolts to engage. These doors are designed for in-between fixing.

Garage Side door factory pre-framed

Between brickwork fixing

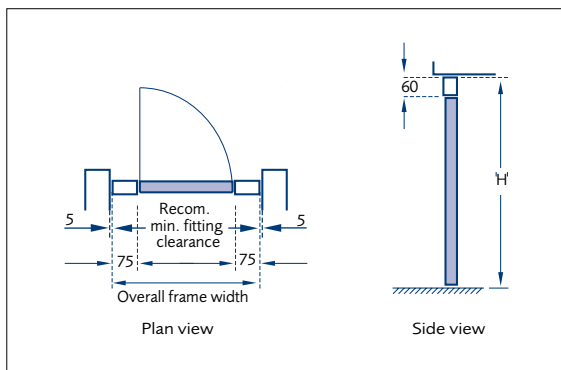

Door specification

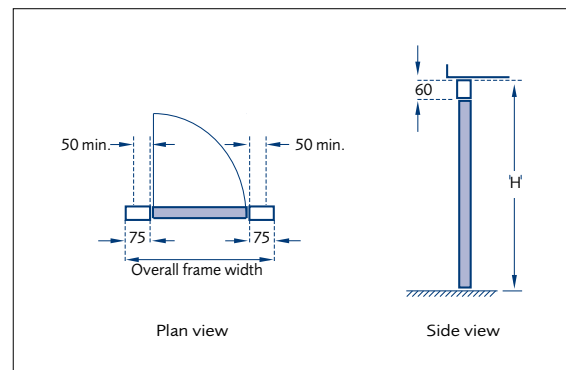

The nominal clear passage clearance is 74 mm less than the opening width and 125 mm less than the opening height. **Not recommended** for behind brickwork fixing.

Side-hinged door factory pre-framed

Between brickwork fixing

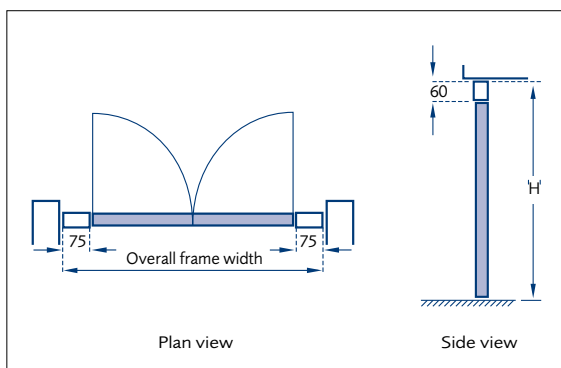

Door specification

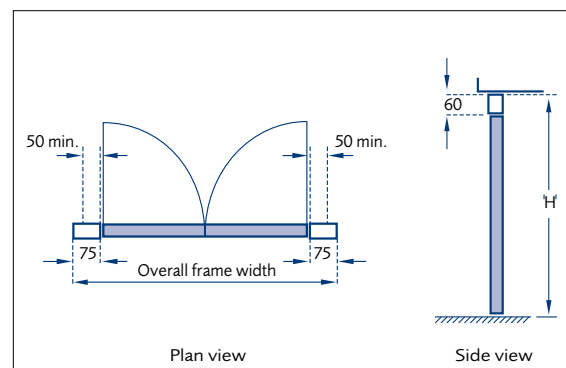

The nominal drive through clearance is 30 mm less than the opening width and 125 mm less than the opening height. **Not recommended** for behind brickwork fixing.

Side-Hinged Garage Door Steel Frame Specifications

	Width	Height	Depth
Side-Hinged Doors	75 mm	60 mm	75 mm

Steel Panel Doors – Specifications

Canopy Gear Specifications

The canopy gear allows the door to travel in vertical tracks and is counterbalanced by an overhead torsion spring. The nominal drive through is 40 mm less than the opening width and 130 mm less than the opening height.

In the open position, the door projects approximately one third of the door height, forming a canopy.

For doors fitted with an operator, please observe operator specifications.

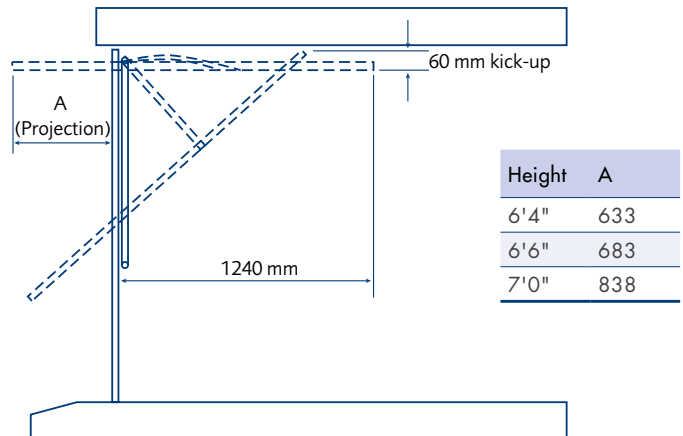

On-site timber frame

Behind brickwork fixing

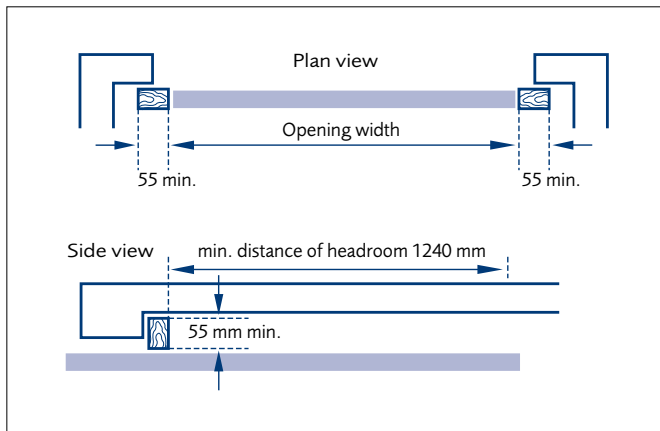

Between brickwork fixing

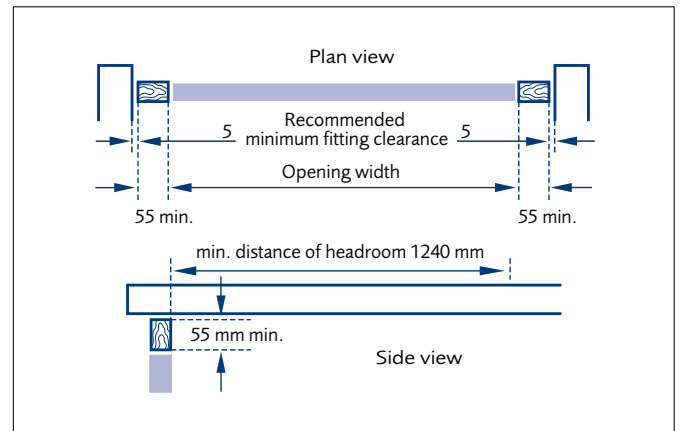

Steel Panel Doors – Specifications

Factory pre-framed with steel box frame

The garage door is supplied factory fitted to a steel box section frame and is secured to the brickwork by using just 7 fixings.

Behind brickwork fixing

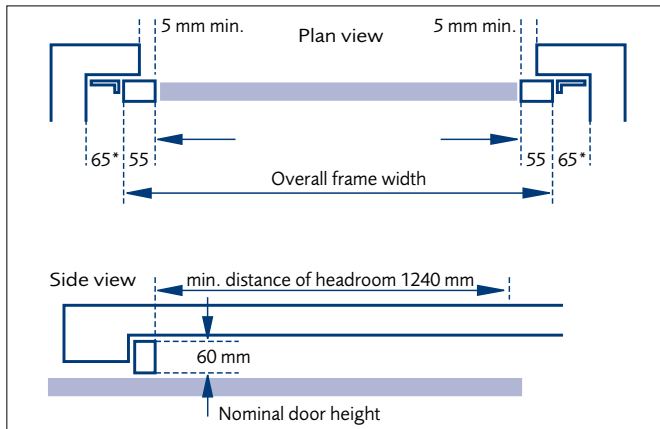

Between brickwork fixing

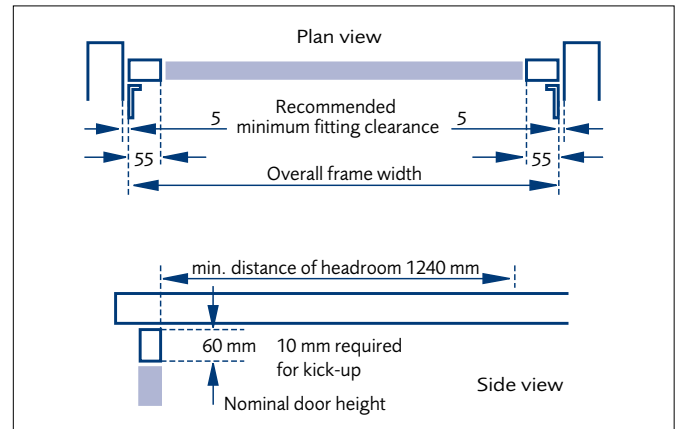

* width of anchor brackets in this position

Up & Over Garage Door Steel Frame Dimensions

	Width	Depth
Canopy steel frame (single door)	55 mm	40 mm
Retractable steel frame (single door)	75 mm	40 mm
Retractable steel frame (double door)	75 mm	80 mm

Steel Panel Doors – Specifications

Single & Double Retractable Gear Specifications

The retractable gear allows the door to be retracted inside the garage when open by means of horizontal overhead tracks supported by wall or ceiling mounted suspension brackets. This gear is available as an option for single doors and comes as standard with double garage doors.

The nominal drive through clearance is 105 mm less than the opening width and 110 mm less than the opening height for single doors and 140 mm less than the opening height for double doors.

For doors fitted with an operator, please observe operator specifications.

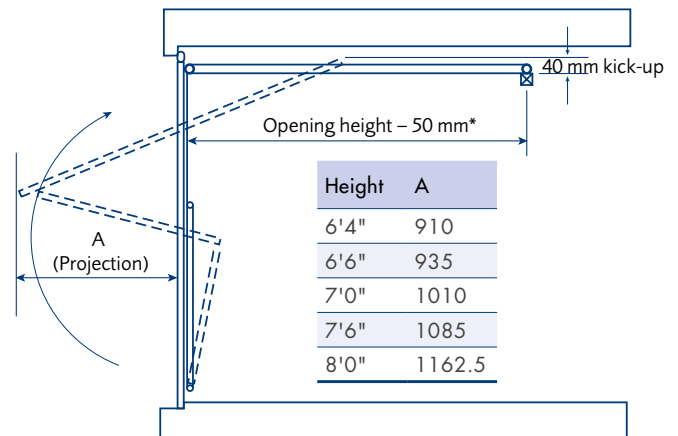

* Only applies to single doors up to 1070.

On-site timber frame

Behind brickwork fixing

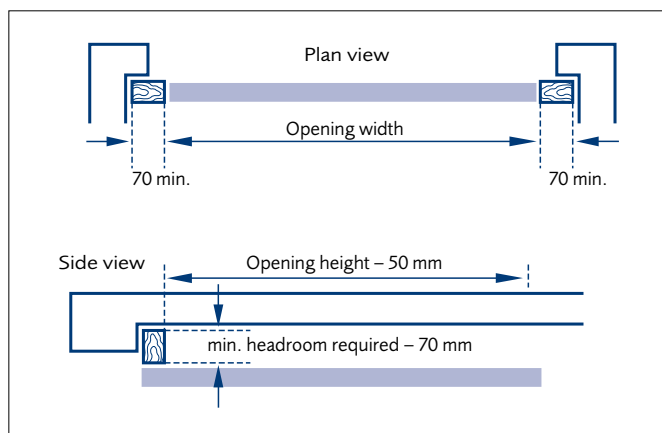

Between brickwork fixing

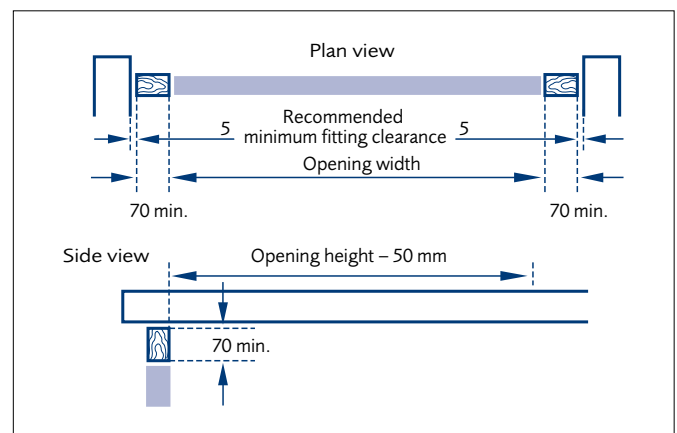

Steel Panel Doors – Specifications

Factory pre-framed with steel box frame

The garage door is supplied factory fitted to a steel box section frame and is secured to the brickwork by using just 7 fixings.

Behind brickwork fixing

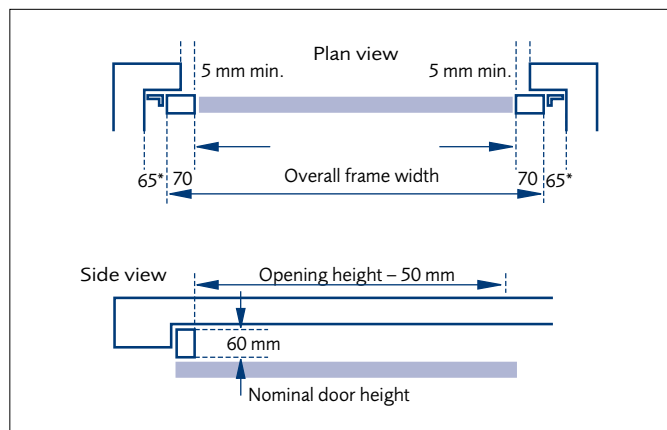

* width of anchor brackets in this position

Between brickwork fixing

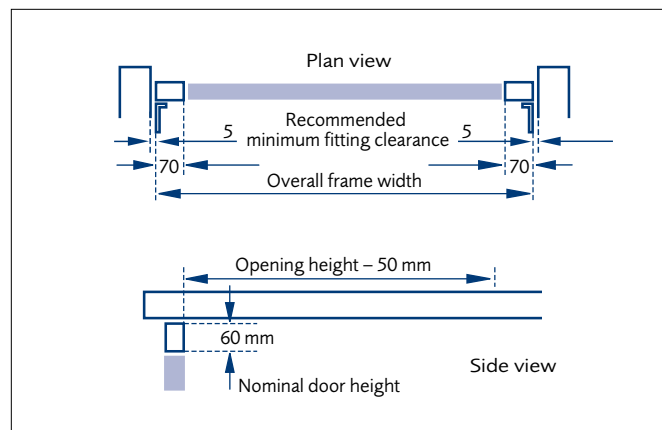

Retractable Plus Gear

For any door up to a width of 2744 mm in any of the three standard heights Retractable Plus Gear is available.

This gear type creates clear drive through width at the crucial wing mirror height.

Door height	Clear height below lifting arms
7'0"	1260
6'6"	1105
6'4"	1055

Steel Sectional Garage Doors

Door sections

Made of galvanised steel. Premium doors have a 42 mm thick insulated door section that is filled with PU-foam (100 % CFC-free). Bottom door section comes with floor seal.

Surface

Outside: Duragrain, Woodgrain embossed, Slategrain or Silkgrain textures with painted or foil coated finishes.

Inside: Pebble texture.

Spring arrangement

All doors up to 4000 mm wide (excluding Silkgrain) come with tension springs as standard and torsion springs are available at extra cost. All doors over 4000 mm wide (excluding Silkgrain) come with torsion springs as standard. Low headroom application available at extra cost. Doors with a Silkgrain surface finish are supplied with tension springs as standard up to 3049 mm wide and torsion springs as standard on doors over 3050 mm wide.

Side frames & Fascia

Sectional doors are designed to be fitted behind the reveals and side frames are supplied white in colour. Cover profiles are available for use with coloured or foil coated door finishes. A single skin fascia is supplied with all doors which is finished in the same colour as the door sections. For Slategrain models, the door section has a Slategrain texture but the cover profiles and fascia are smooth.

Colours

Steel Woodgrain and Silkgrain doors can be ordered in almost any colour from the RAL colour chart. Slategrain is only available in standard RAL colours and Traffic White (RAL 9016).

Standard colours available (Silk Gloss):

- Light Ivory (RAL 1015)
- Moss Green (RAL 6005)
- Fir Green (RAL 6009)
- Basalt Grey (RAL 7012)
- Slate Grey (RAL 7015)
- Anthracite Grey (RAL 7016)
- Titan Metallic (CH 703)
- Stone Grey (RAL 7030)
- Light grey (RAL 7035)
- Agate Grey (RAL 7038)
- Quartz Grey (RAL 7039)
- Window Grey (RAL 7040)
- Terra Brown (RAL 8028)
- Jet Black (RAL 9005)
- Chartwell Green (BS 14C35)

Standard colours available (Silk Matt):

- White Aluminum (Silk Matt) (RAL 9006)
- Grey Aluminium (Silk Matt) (RAL 9007)

Steel Sectional Garage Doors

Timber effect foil coated doors are available in the following five finishes:

Golden Oak, Dark Oak, Night Oak, Rosewood and Winchester Oak. Only Golden Oak and Rosewood surface finishes are kept as stock door sizes (prices highlighted in bold) for timber effect sectional garage doors. Dark Oak, Night Oak and Winchester Oak surface finishes are not stocked, but are made to order. Foil coated finish also available in Titan Metallic (CH 703)

Duragrain standard colour finishes are:

Standard colours are:

- Concrete
- Grigio Scuro
- Cherry
- Noce Sorrento Balsamico
- Teak
- White Brushed
- Beige
- Nature Oak
- Rusty Steel
- Noce Sorrento Nature
- Used look
- White Oak
- Mocca
- Bamboo
- Pine
- Sapele
- Terra Walnut
- White Oiled Oak
- Grigio
- Burned Oak
- Rusty Oak
- Sheffield
- Colonial Walnut
- White Washed Oak
- Burned Oak
- Spruce
- Malt Oak

Vertical Duragrain Standard Colours:

- Burned Oak
- Spruce
- Malt Oak
- Sheffield
- Whiteoiled Oak
- Whitewashed Oak

Handle

Sectional doors in shaded boxes are generally supplied ex-works for automatic operation, i.e. without handle hole and lock. Factory-fitted handle and lock are available with an increased lead-time. All other doors are on a 4 to 6 week lead-time. For electrical operation of a garage with no other personal access, an emergency release kit must be fitted

Packaging

Sectional doors are provided in a palletted format shrink wrapped for easy handling.

Stock availability

Popular sectional doors are generally ex-stock in Traffic White (RAL 9016) and Terra Brown (RAL 8028) in some sizes, other sizes and colour options require up to 6 weeks lead-time. Contact sales office for further details.

Gears

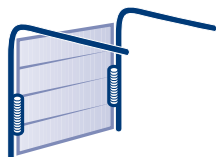

Tension spring

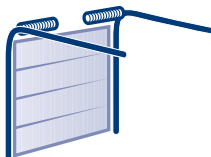

Torsion spring

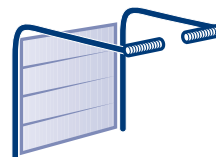

Low headroom torsion spring fitting

Steel Sectional Garage Doors

Window options

Georgian design

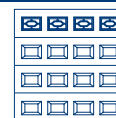
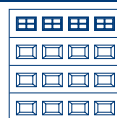
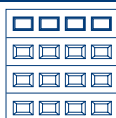

Prices £ stated per window Window frames white as standard	Standard	Cross	Diamond
Premium - Woodgrain ¹	159	197	197
Premium - Timber effect ²	203	240	240

Linear small design

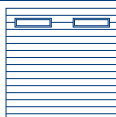

Prices £ stated per window Window frames white as standard	Linear 1
Premium - Woodgrain ¹	159

Linear medium design



Prices £ stated per window Window frames white as standard	Standard	Cross	Diamond	Linear 1	Linear 2
Premium - Woodgrain, Silkgrain ¹ , Slategrain	159	197	197	159	194
Premium - Timber effect ²	203	240	240	203	237

Linear large design

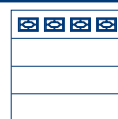

Prices £ stated per window Window frames white as standard	Standard	Cross	Diamond	Linear 1	Linear 2	Linear 3
Premium - Silkgrain, Slategrain	159	197	197	159	194	249
Premium - Timber effect ²	203	240	240	203	237	281
Premium - Duragrain	203	240	240	203	237	281

¹ Colours available at surcharge per window (£44 for standard colour, £73 for non standard colour).

² Window frames are painted in a colour to best complement the colour of the foil coat (colour incl. in price).

Please note, window frames are painted in a colour to complement the colour of the sectional garage door.

Steel Sectional Garage Doors

Linear, Medium or Large (overall frame dimension: 395 mm x 270 mm)

Door widths from 2000 mm to 2125 mm wide have 3 windows, 2126 mm to 2750 mm wide have 4 windows, 2751 mm to 3500 mm wide have 5 windows, 3501 mm to 4000 mm wide have 6 windows, 4001 mm to 4750 mm wide have 7 windows and doors of 4751 mm up to 5500 mm wide have 8 windows.

For Georgian doors

Door widths up to 2125 mm wide have 3 windows, 2126 mm to 2750 mm wide have 4 windows, 2751 mm to 3500 mm wide have 5 windows, 3501 mm to 4000 mm wide have 6 windows, 4001 mm to 4750 mm wide have 7 windows and doors of 4751 mm to 5500 mm wide have 8 windows.

Linear 1 (overall frame dimension: 680 mm x 210 mm)

Door widths from 2000 mm to 2500 mm wide have 2 windows, 2501 mm to 3500 mm wide have 3 windows, 3501 mm to 4500 mm wide have 4 windows and doors of 4500 mm to 5500 mm wide have 5 windows.

Linear 2 (overall frame dimension: 620 mm x 270 mm)

Doors widths from 2000 mm to 2240 mm wide have 2 windows, 2241 mm to 2970 mm wide have 3 windows, 2971 mm to 3690 mm wide have 4 windows, 3691 mm to 4420 mm wide have 5 windows, 4421 mm to 5140 mm wide have 6 windows and doors of 5141 mm to 5500 mm wide have 7 windows.

Linear 3 (overall frame dimension: 1004 mm x 270 mm)

Door widths from 2250 mm to 3400 mm wide have 2 windows, 3401 mm to 4490 mm wide have 3 windows and doors of 4491 mm to 5500 mm wide have 4 windows.

Please state on order if clear or crystal panes. Georgian sectional doors under 7 ft wide only have 3 pressings.

Secured by Design – Free optional upgrade available after installation

The following criteria must be met to be eligible for Secured by Design accreditation:

- Premium 42 mm sectional door (without windows)
- Fitted behind the opening
- Automated with a GaraMatic operator (sold separately)
- Door must be fitted to SBD standard, unmodified and registered with Garador
- Sectional Doors must be fitted with a Garamatic 10 s4 only



Steel Sectional Garage Doors

Georgian design

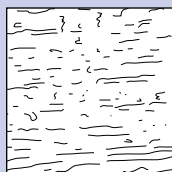
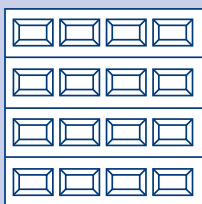

Woodgrain



Brickwork opening Width x Height (mm x mm)		Size Code	Premium	Surcharge for Standard Colours	Surcharge for Non-Std. Colours
2080 x 2000	I	61066	1885	255	411
2080 x 2080	I	610610	1908	266	428
2134 x 2000	I	7066	1949	262	421
2134 x 2125	I	7070	1977	278	447
2250 x 1900	M	7462	2003	262	421
2250 x 2000	M	7466	2060	276	444
2250 x 2125	M	7470	2064	294	472
2286 x 2000	I	7666	1949	280	452
2286 x 2125	I	7670	1977	298	480
2286 x 2250	I	7674	1969	316	508
2286 x 2375	I	7679	2104	333	536
2286 x 2500	I	7682	2100	351	565
2375 x 1900	M	7962	2003	277	445
2375 x 2000	M	7966	2004	292	469
2375 x 2125	M	7970	2011	309	498
2375 x 2250	M	7974	2097	328	527
2438 x 2000	I	8066	1994	299	482
2438 x 2125	I	8070	2079	318	512
2438 x 2250	I	8074	2077	336	542
2438 x 2375	I	8079	2196	355	572
2438 x 2500	I	8082	2197	374	602
2500 x 1900	M	8262	2003	292	469
2500 x 2000	M	8266	2004	306	493
2500 x 2125	M	8270	2011	326	524
2500 x 2250	M	8274	2097	346	555
2500 x 2375	M	8279	2198	364	586
2500 x 2500	M	8282	2200	383	617
2500 x 2750	M	8290	2384	421	679
2591 x 2000	I	8666	2058	318	512
2591 x 2125	I	8670	2091	338	544
2625 x 2125	M	8770	2176	343	551
2740 x 2000	I	9066	2241	336	541
2750 x 2125	I	9070	2274	358	574

Prices in bold are generally a stock item. Non-bold prices require a longer lead-time.

Purpose-made sizes available upon request. Non standard colours also available upon request. Doors supplied without locking as standard (see options on page 86 for handles). For window options please see page 62



Imperial door sizes.



Metric door sizes. Extended lead time of 4-6 weeks.



Supplied as standard with tension spring gear. Torsion spring fitting available for Premium doors at £120 surcharge.



Supplied as standard with torsion spring gear. Low headroom fitting available at £186 surcharge.

Purpose-made sizes available upon request. Non standard colours also available upon request. Doors supplied without locking as standard (see options on page 89 for handles). For window options please see page 64.

Steel Sectional Garage Doors

Georgian design

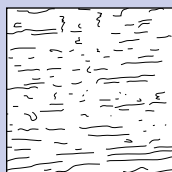
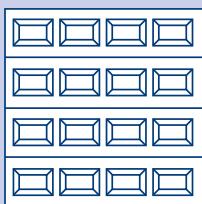

Woodgrain



Brickwork opening Width x Height (mm x mm)		Size Code	Premium	Surcharge for Standard Colours	Surcharge for Non-Std. Colours
2750 x 2000	M	9166	2428	337	543
2750 x 2125	M	9170	2476	358	576
2750 x 2250	M	9174	2566	380	611
2750 x 2375	M	9179	2587	401	645
2750 x 2500	M	9182	2672	421	679
2896 x 2000	I	9666	2352	355	572
2896 x 2125	I	9670	2399	377	607
3000 x 2000	M	91066	2551	367	592
3000 x 2125	M	91070	2550	391	630
3000 x 2250	M	91074	2629	414	666
3000 x 2375	M	91079	2677	437	704
3000 x 2500	M	91082	2762	460	740
3000 x 3000	M	910910	3594	551	887
3048 x 2000	I	1066	2258	374	602
3048 x 2125	I	1070	2304	398	639
3250 x 2000	M	10866	2649	399	641
3250 x 2125	M	10870	2719	424	682
3250 x 2250	M	10874	2808	448	721
3353 x 2000	I	1166	2698	411	662
3353 x 2125	I	1170	2746	437	704
3500 x 2000	M	11666	2885	429	690
3500 x 2125	M	11670	2960	456	734
3500 x 2250	M	11674	3054	483	777
3658 x 2000	I	1266	3112	448	722
3658 x 2125	I	1270	3193	476	767
3750 x 2000	M	12466	3115	460	740
3750 x 2125	M	12470	3196	489	787
3750 x 2250	M	12474	3296	517	832
3962 x 2000	I	1366	3310	486	782
3962 x 2125	I	1370	3357	516	830
4000 x 2000	M	13266	3334	490	789
4000 x 2125	M	13270	3420	521	839
4000 x 2250	M	13274	3529	551	887

Prices in bold are generally a stock item. Non-bold prices require a longer lead-time.

Purpose-made sizes available upon request. Non standard colours also available upon request. Doors supplied without locking as standard (see options on page 86 for handles). For window options please see page 62



Imperial door sizes.



Metric door sizes. Extended lead time of 4-6 weeks.



Supplied as standard with tension spring gear. Torsion spring fitting available for Premium doors at £120 surcharge.



Supplied as standard with torsion spring gear. Low headroom fitting available at £186 surcharge.

Purpose-made sizes available upon request. Non standard colours also available upon request. Doors supplied without locking as standard (see options on page 89 for handles). For window options please see page 64.

Steel Sectional Garage Doors

Georgian design

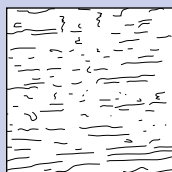
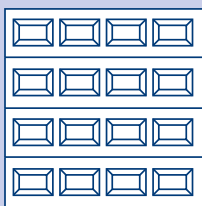

Woodgrain



Brickwork opening Width x Height (mm x mm)		Size Code	Premium	Surcharge for Standard Colours	Surcharge for Non-Std. Colours
4250 x 2000	M	131166	3440	521	839
4250 x 2125	M	131170	3535	553	891
4250 x 2250	M	131174	3641	586	944
4267 x 2000	I	1466	3445	523	842
4267 x 2125	I	1470	3499	556	895
4420 x 2000	I	14666	3530	542	872
4420 x 2125	I	14670	3628	576	927
4500 x 2000	M	14966	3534	551	887
4500 x 2125	M	14970	3639	586	944
4500 x 2250	M	14974	3755	621	1000
4572 x 2000	I	1566	3635	561	902
4572 x 2125	I	1570	3694	596	959
4725 x 2000	I	15666	3637	579	932
4725 x 2125	I	15670	3746	616	990
4750 x 2000	M	15766	3641	582	937
4750 x 2125	M	15770	3750	619	995
4750 x 2250	M	15774	3861	655	1055
4877 x 2000	I	1666	3739	598	962
4877 x 2125	I	1670	3825	635	1022
5000 x 2000	M	16566	3743	612	986
5000 x 2125	M	16570	3829	652	1048
5000 x 2250	M	16574	3951	689	1110
5000 x 2375	M	16579	4096	728	1172
5000 x 2500	M	16582	4085	766	1233
5500 x 2000	M	18166	4047	674	1085
5500 x 2125	M	18170	4225	716	1153
5500 x 2250	M	18174	4468	759	1222

Prices in bold are generally a stock item. Non-bold prices require a longer lead-time.

Purpose-made sizes available upon request. Non standard colours also available upon request. Doors supplied without locking as standard (see options on page 86 for handles). For window options please see page 62



Imperial door sizes.



Metric door sizes. Extended lead time of 4-6 weeks.



Supplied as standard with tension spring gear. Torsion spring fitting available for Premium doors at £120 surcharge.



Supplied as standard with torsion spring gear. Low headroom fitting available at £186 surcharge.

Purpose-made sizes available upon request. Non standard colours also available upon request. Doors supplied without locking as standard (see options on page 89 for handles). For window options please see page 64.

Steel Sectional Garage Doors

Linear small design

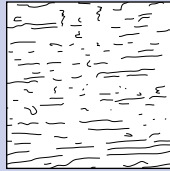
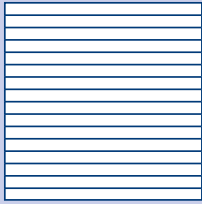

Woodgrain



Brickwork opening Width x Height (mm x mm)		Size Code	Premium	Surcharge for Standard Colours	Surcharge for Non-Std. Colours
2080 x 2000	I	61066	1491	255	411
2080 x 2080	I	610610	1547	266	428
2134 x 2000	I	7066	1544	262	421
2134 x 2125	I	7070	1597	278	447
2250 x 1900	M	7462	1629	262	421
2250 x 2000	M	7466	1679	276	444
2250 x 2125	M	7470	1683	294	472
2286 x 2000	I	7666	1544	280	452
2286 x 2125	I	7670	1597	298	480
2286 x 2250	I	7674	1617	316	508
2286 x 2375	I	7679	1746	333	536
2286 x 2500	I	7682	1740	351	565
2375 x 1900	M	7962	1629	277	445
2375 x 2000	M	7966	1631	292	469
2375 x 2125	M	7970	1632	309	498
2375 x 2250	M	7974	1662	328	527
2438 x 2000	I	8066	1623	299	482
2438 x 2125	I	8070	1687	318	512
2438 x 2250	I	8074	1672	336	542
2438 x 2375	I	8079	1766	355	572
2438 x 2500	I	8082	1770	374	602
2500 x 1900	M	8262	1629	292	469
2500 x 2000	M	8266	1631	306	493
2500 x 2125	M	8270	1632	326	524
2500 x 2250	M	8274	1662	346	555
2500 x 2375	M	8279	1756	364	586
2500 x 2500	M	8282	1759	383	617
2500 x 2750	M	8290	2136	421	679
2591 x 2000	I	8666	1623	318	512
2591 x 2125	I	8670	1687	338	544
2625 x 2125	M	8770	1848	343	551
2740 x 2000	I	9066	1758	336	541
2740 x 2125	I	9070	1820	358	574
2750 x 2000	M	9166	1873	337	543
2750 x 2125	M	9170	1934	358	576

Prices in bold are generally a stock item. Non-bold prices require a longer lead-time.



Imperial door sizes.



Metric door sizes. Extended lead time of 4-6 weeks.



Supplied as standard with tension spring gear. Torsion spring fitting available for Premium doors at £120 surcharge.



Supplied as standard with torsion spring gear. Low headroom fitting available at £186 surcharge.

Steel Sectional Garage Doors

Linear small design

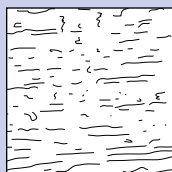
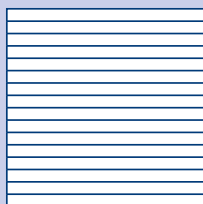

Woodgrain



Brickwork opening
Width x Height
(mm x mm)

Size
Code

Premium

Surcharge for
Standard Colours

Surcharge for
Non-Std. Colours

Brickwork opening Width x Height (mm x mm)	Size Code	Premium	Surcharge for Standard Colours	Surcharge for Non-Std. Colours	
2750 x 2250	M	9174	1943	380	611
2750 x 2375	M	9179	1995	401	645
2750 x 2500	M	9182	2084	421	679
2896 x 2000	I	9666	1837	355	572
2896 x 2125	I	9670	1913	377	607
3000 x 2000	M	91066	2103	367	592
3000 x 2125	M	91070	2102	391	630
3000 x 2250	M	91074	2119	414	666
3000 x 2375	M	91079	2175	437	704
3000 x 2500	M	91082	2264	460	740
3000 x 3000	M	910910	2748	551	887
3048 x 2000	I	1066	1775	374	602
3048 x 2125	I	1070	1840	398	639
3250 x 2000	M	10866	2114	399	641
3250 x 2125	M	10870	2175	424	682
3250 x 2250	M	10874	2222	448	721
3353 x 2000	I	1166	2095	411	662
3353 x 2125	I	1170	2180	437	704
3500 x 2000	M	11666	2258	429	690
3500 x 2125	M	11670	2315	456	734
3500 x 2250	M	11674	2364	483	777
3658 x 2000	I	1266	2398	448	722
3658 x 2125	I	1270	2468	476	767
3750 x 2000	M	12466	2382	460	740
3750 x 2125	M	12470	2453	489	787
3750 x 2250	M	12474	2501	517	832
3962 x 2000	I	1366	2526	486	782
3962 x 2125	I	1370	2603	516	830
4000 x 2000	M	13266	2510	490	789
4000 x 2125	M	13270	2586	521	839
4000 x 2250	M	13274	2640	551	887
4250 x 2000	M	131166	2652	521	839
4250 x 2125	M	131170	2730	553	891
4250 x 2250	M	131174	2789	586	944
4267 x 2000	I	1466	2650	523	842
4267 x 2125	I	1470	2757	556	895
4420 x 2000	I	14666	2739	542	872
4420 x 2125	I	14670	2850	576	927

Prices in bold are generally a stock item. Non-bold prices require a longer lead-time.



Imperial door sizes.



Metric door sizes. Extended lead time of 4-6 weeks.



Supplied as standard with tension spring gear. Torsion spring fitting available for Premium doors at £120 surcharge.



Supplied as standard with torsion spring gear. Low headroom fitting available at £186 surcharge.

Steel Sectional Garage Doors

Linear small design

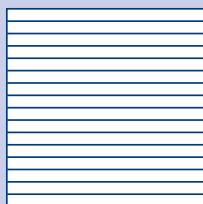

Woodgrain



Brickwork opening
Width x Height
(mm x mm)

Size
Code

Premium

Surcharge for
Standard Colours

Surcharge for
Non-Std. Colours

Brickwork opening Width x Height (mm x mm)	Size Code	Premium	Surcharge for Standard Colours	Surcharge for Non-Std. Colours
4500 x 2000	M	2787	551	887
4500 x 2125	M	2870	586	944
4500 x 2250	M	2925	621	1000
4572 x 2000	I	2790	561	902
4572 x 2125	I	2899	596	959
4725 x 2000	I	2892	579	932
4725 x 2125	I	2976	616	990
4750 x 2000	M	2872	582	937
4750 x 2125	M	2956	619	995
4750 x 2250	M	3013	655	1055
4877 x 2000	I	2908	598	962
4877 x 2125	I	3024	635	1022
5000 x 2000	M	2956	612	986
5000 x 2125	M	3016	652	1048
5000 x 2250	M	3077	689	1110
5000 x 2375	M	3141	728	1172
5000 x 2500	M	3204	766	1233
5500 x 2000	M	3162	674	1085
5500 x 2125	M	3251	716	1153
5500 x 2250	M	3331	759	1222

Prices in bold are generally a stock item. Non-bold prices require a longer lead-time.



Imperial door sizes.



Metric door sizes. Extended lead time of 4-6 weeks.







Supplied as standard with tension spring gear. Torsion spring fitting available for Premium doors at £120 surcharge.

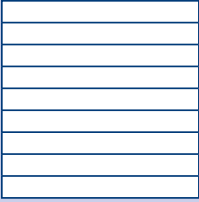
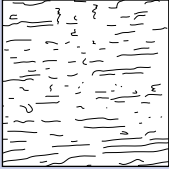
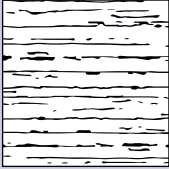
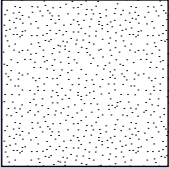

Supplied as standard with torsion spring gear. Low headroom fitting available at £186 surcharge.



Steel Sectional Garage Doors

Linear medium design									
	  								
	<p>Woodgrain Slategrain Silkgrain ¹</p>   								
Brickwork opening Width x Height (mm x mm)		Size Code	Premium	Premium	Premium	Surcharge for Standard Colours	Surcharge for Non-Std. Colours		
2080 x 2000	I	61066	1491	1491	1834	255	411		
2080 x 2080	I	610610	1547	1547	1905	266	428		
2134 x 2000	I	7066	1544	1544	1834	262	421		
2134 x 2125	I	7070	1597	1597	1905	278	447		
2250 x 1900	M	7462	1629	1629	1951	262	421		
2250 x 2000	M	7466	1679	1679	1990	276	444		
2250 x 2125	M	7470	1683	1683	1993	294	472		
2286 x 2000	I	7666	1544	1544	1834	280	452		
2286 x 2125	I	7670	1597	1597	1905	298	480		
2286 x 2250	I	7674	1617	1617	1992	316	508		
2286 x 2375	I	7679	1746	1746	2080	333	536		
2286 x 2500	I	7682	1740	1740	2162	351	565		
2375 x 1900	M	7962	1629	1629	1951	277	445		
2375 x 2000	M	7966	1631	1631	1957	292	469		
2375 x 2125	M	7970	1632	1632	1963	309	498		
2375 x 2250	M	7974	1662	1662	2033	328	527		
2438 x 2000	I	8066	1623	1623	1941	299	482		
2438 x 2125	I	8070	1687	1687	2025	318	512		
2438 x 2250	I	8074	1672	1672	2083	336	542		
2438 x 2375	I	8079	1766	1766	2183	355	572		
2438 x 2500	I	8082	1770	1770	2214	374	602		
2500 x 1900	M	8262	1629	1629	1951	292	469		
2500 x 2000	M	8266	1631	1631	1957	306	493		
2500 x 2125	M	8270	1632	1632	1963	326	524		
2500 x 2250	M	8274	1662	1662	2033	346	555		
2500 x 2375	M	8279	1756	1756	2165	364	586		
2500 x 2500	M	8282	1759	1759	2161	383	617		
2500 x 2750	M	8290	2136	2136	-	421	679		
2591 x 2000	I	8666	1623	1623	1941	318	512		
2591 x 2125	I	8670	1687	1687	2025	338	544		
2625 x 2125	M	8770	1848	1848	2243	343	551		
2740 x 2000	I	9066	1758	1758	2128	336	541		

¹ Silkgrain surface supplied with tension spring gear up to 3048 mm wide.

Prices in bold are generally a stock item. Non-bold prices require a longer lead-time.

- I** Imperial door sizes.
- M** Metric door sizes. Extended lead time of 4-6 weeks.

-  Supplied as standard with tension spring gear. Torsion spring fitting available for Premium doors at £120 surcharge.
-  Supplied as standard with torsion spring gear. Low headroom fitting available at £186 surcharge.

Purpose-made sizes available upon request. Non standard colours also available upon request. Doors supplied without locking as standard (see options on page 89 for handles). For window options please see page 64.

For Slategrain models, the door section has a Slategrain texture but the cover profiles and fascia are smooth.

Steel Sectional Garage Doors

Linear medium design

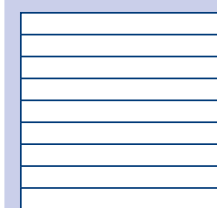

Woodgrain

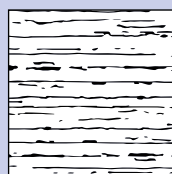

Slategrain

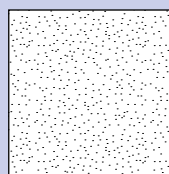

Silkgrain ¹



Brickwork opening
Width x Height
(mm x mm)

Size
Code

Premium

Premium

Premium

Surcharge
for
Standard
Colours

Surcharge
for
Non-Std.
Colours

2740 x 2125	I	9070	1820	1820	2212	358	574
2750 x 2000	M	9166	1873	1873	2205	337	543
2750 x 2125	M	9170	1934	1934	2293	358	576
2750 x 2250	M	9174	1943	1943	2345	380	611
2750 x 2375	M	9179	1995	1995	2422	401	645
2750 x 2500	M	9182	2084	2084	2531	421	679
2896 x 2000	I	9666	1837	1837	2241	355	572
2896 x 2125	I	9670	1913	1913	2330	377	607
3000 x 2000	M	91066	2103	2103	2515	367	592
3000 x 2125	M	91070	2102	2102	2513	391	630
3000 x 2250	M	91074	2119	2119	2539	414	666
3000 x 2375	M	91079	2175	2175	2655	437	704
3000 x 2500	M	91082	2264	2264	2770	460	740
3000 x 3000	M	910910	2748	2748	3352	551	887
3048 x 2000	I	1066	1775	1775	2241	374	602
3048 x 2125	I	1070	1840	1840	2330	398	639
3250 x 2000	M	10866	2114	2114	2661	399	641
3250 x 2125	M	10870	2175	2175	2739	424	682
3250 x 2250	M	10874	2222	2222	2813	448	721
3353 x 2000	I	1166	2095	2095	2682	411	662
3353 x 2125	I	1170	2180	2180	2789	437	704
3500 x 2000	M	11666	2258	2258	2830	429	690
3500 x 2125	M	11670	2315	2315	2906	456	734
3500 x 2250	M	11674	2364	2364	2992	483	777
3658 x 2000	I	1266	2398	2398	2973	448	722
3658 x 2125	I	1270	2468	2468	3068	476	767
3750 x 2000	M	12466	2382	2382	2895	460	740
3750 x 2125	M	12470	2453	2453	2987	489	787
3750 x 2250	M	12474	2501	2501	3078	517	832
3962 x 2000	I	1366	2526	2526	3117	486	782

¹ Silkgrain surface supplied with tension spring gear up to 3048 mm wide.

Prices in bold are generally a stock item. Non-bold prices require a longer lead-time.



Imperial door sizes.



Metric door sizes. Extended lead time of 4-6 weeks.



Supplied as standard with tension spring gear. Torsion spring fitting available for Premium doors at £120 surcharge.



Supplied as standard with torsion spring gear. Low headroom fitting available at £186 surcharge.

Purpose-made sizes available upon request. Non standard colours also available upon request. Doors supplied without locking as standard (see options on page 89 for handles). For window options please see page 64.

For Slategrain models, the door section has a Slategrain texture but the cover profiles and fascia are smooth.

Steel Sectional Garage Doors

Linear medium design							
Brickwork opening Width x Height (mm x mm)	Size Code	Premium	Premium	Premium	Surcharge for Standard Colours	Surcharge for Non-Std. Colours	
							Woodgrain
3962 x 2125	I	1370	2603	2603	3206	516	830
4000 x 2000	M	13266	2510	2510	3044	490	789
4000 x 2125	M	13270	2586	2586	3121	521	839
4000 x 2250	M	13274	2640	2640	3223	551	887
4250 x 2000	M	131166	2652	2652	3174	521	839
4250 x 2125	M	131170	2730	2730	3275	553	891
4250 x 2250	M	131174	2789	2789	3368	586	944
4267 x 2000	I	1466	2650	2650	3209	523	842
4267 x 2125	I	1470	2757	2757	3341	556	895
4420 x 2000	I	14666	2739	2739	3293	542	872
4420 x 2125	I	14670	2850	2850	3427	576	927
4500 x 2000	M	14966	2787	2787	3338	551	887
4500 x 2125	M	14970	2870	2870	3443	586	944
4500 x 2250	M	14974	2925	2925	3518	621	1000
4572 x 2000	I	1566	2790	2790	3317	561	902
4572 x 2125	I	1570	2899	2899	3460	596	959
4725 x 2000	I	15666	2892	2892	3383	579	932
4725 x 2125	I	15670	2976	2976	3514	616	990
4750 x 2000	M	15766	2872	2872	3406	582	937
4750 x 2125	M	15770	2956	2956	3519	619	995
4750 x 2250	M	15774	3013	3013	3615	655	1055
4877 x 2000	I	1666	2908	2908	3442	598	962
4877 x 2125	I	1670	3024	3024	3580	635	1022
5000 x 2000	M	16566	2956	2956	3541	612	986
5000 x 2125	M	16570	3016	3016	3634	652	1048
5000 x 2250	M	16574	3077	3077	3727	689	1110
5000 x 2375	M	16579	3141	3141	3824	728	1172
5000 x 2500	M	16582	3204	3204	3916	766	1233
5500 x 2000	M	18166	3162	3162	3820	674	1085
5500 x 2125	M	18170	3251	3251	3926	716	1153
5500 x 2250	M	18174	3331	3331	4024	759	1222

¹ Silkgrain surface supplied with tension spring gear up to 3048 mm wide.

Prices in bold are generally a stock item. Non-bold prices require a longer lead-time.

- I** Imperial door sizes.
- M** Metric door sizes. Extended lead time of 4-6 weeks.

- Supplied as standard with tension spring gear. Torsion spring fitting available for Premium doors at £120 surcharge.
- Supplied as standard with torsion spring gear. Low headroom fitting available at £186 surcharge.

Purpose-made sizes available upon request. Non standard colours also available upon request. Doors supplied without locking as standard (see options on page 89 for handles). For window options please see page 64.

For Slategrain models, the door section has a Slategrain texture but the cover profiles and fascia are smooth.

Steel Sectional Garage Doors

Linear medium design

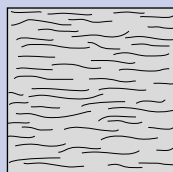

Timber Effect / Titan (CH 703)



Brickwork opening
Width x Height
(mm x mm)

Size
Code

Premium

Brickwork opening Width x Height (mm x mm)	Size Code	Size Code	Premium
2080 x 2000	I	61066	2017
2080 x 2080	I	610610	2096 ²
2134 x 2000	I	7066	2017 ¹
2134 x 2125	I	7070	2096 ¹
2250 x 1900	M	7462	2160
2250 x 2000	M	7466	2200
2250 x 2125	M	7470	2201
2286 x 2000	I	7666	2017 ¹
2286 x 2125	I	7670	2096 ¹
2286 x 2250	I	7674	2193 ¹
2286 x 2375	I	7679	2290
2286 x 2500	I	7682	2381
2375 x 1900	M	7962	2159
2375 x 2000	M	7966	2161
2375 x 2125	M	7970	2166
2375 x 2250	M	7974	2244
2438 x 2000	I	8066	2139 ¹
2438 x 2125	I	8070	2232 ¹
2438 x 2250	I	8074	2296 ³
2438 x 2375	I	8079	2406
2438 x 2500	I	8082	2441
2500 x 1900	M	8262	2159
2500 x 2000	M	8266	2161
2500 x 2125	M	8270	2166
2500 x 2250	M	8274	2244
2500 x 2375	M	8279	2392
2500 x 2500	M	8282	2385
2500 x 2750	M	8290	-
2591 x 2000	I	8666	2139
2591 x 2125	I	8670	2232 ¹

¹ Available as stock door in Rosewood or Golden Oak timber effect.

² Available as stock door in Rosewood timber effect.

³ Available as stock door in Golden Oak timber effect.

Prices in bold are generally a stock item. Non-bold prices require a longer lead-time.



Imperial door sizes.



Metric door sizes. Extended lead time of 4-6 weeks.





Supplied as standard with tension spring gear. Torsion spring fitting available for Premium doors at £120 surcharge.



Supplied as standard with torsion spring gear. Low headroom fitting available at £186 surcharge.

Purpose-made sizes available upon request. Non standard colours also available upon request. Doors supplied without locking as standard (see options on page 89 for handles). For window options please see page 64.

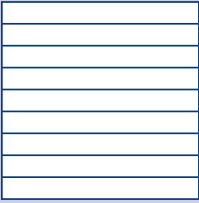
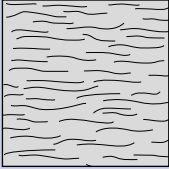
Steel Sectional Garage Doors

Linear medium design			
Brickwork opening Width x Height (mm x mm)	Size Code	Premium	
			  Timber Effect / Titan (CH 703) 
2625 x 2125	M	8770	2485
2740 x 2000	I	9066	2351
2740 x 2125	I	9070	2444 ¹
2750 x 2000	M	9166	2442
2750 x 2125	M	9170	2541
2750 x 2250	M	9174	2596
2750 x 2375	M	9179	2683
2750 x 2500	M	9182	2805
2896 x 2000	I	9666	2479
2896 x 2125	I	9670	2577
3000 x 2000	M	91066	2795
3000 x 2125	M	91070	2791
3000 x 2250	M	91074	2818
3000 x 2375	M	91079	2948
3000 x 2500	M	91082	3077
3000 x 3000	M	910910	3728
3048 x 2000	I	1066	2479
3048 x 2125	I	1070	2577 ³
3250 x 2000	M	10866	2961
3250 x 2125	M	10870	3048
3250 x 2250	M	10874	3130
3353 x 2000	I	1166	2978
3353 x 2125	I	1170	3097
3500 x 2000	M	11666	3152
3500 x 2125	M	11670	3238
3500 x 2250	M	11674	3332
3658 x 2000	I	1266	3308
3658 x 2125	I	1270	3414 ³
3750 x 2000	M	12466	3226
3750 x 2125	M	12470	3330
3750 x 2250	M	12474	3431
3962 x 2000	I	1366	3471

¹ Available as stock door in Rosewood or Golden Oak timber effect.

² Available as stock door in Rosewood timber effect.

³ Available as stock door in Golden Oak timber effect.

Prices in bold are generally a stock item. Non-bold prices require a longer lead-time.



Imperial door sizes.



Metric door sizes. Extended lead time of 4-6 weeks.





Supplied as standard with tension spring gear. Torsion spring fitting available for Premium doors at £120 surcharge.



Supplied as standard with torsion spring gear. Low headroom fitting available at £186 surcharge.

Purpose-made sizes available upon request. Non standard colours also available upon request. Doors supplied without locking as standard (see options on page 89 for handles). For window options please see page 64.

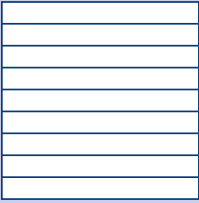
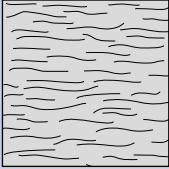
Steel Sectional Garage Doors

Linear medium design			
Brickwork opening Width x Height (mm x mm)	Size Code	Premium	Price
			
			
			Timber Effect / Titan (CH 703)
			
			Premium
3962 x 2125	I	1370	3571 ³
4000 x 2000	M	13266	3396
4000 x 2125	M	13270	3482
4000 x 2250	M	13274	3595
4250 x 2000	M	131166	3545
4250 x 2125	M	131170	3656
4250 x 2250	M	131174	3761
4267 x 2000	I	1466	3576 ¹
4267 x 2125	I	1470	3722 ¹
4420 x 2000	I	14666	3669
4420 x 2125	I	14670	3820 ¹
4500 x 2000	M	14966	3731
4500 x 2125	M	14970	3847
4500 x 2250	M	14974	3930
4572 x 2000	I	1566	3698
4572 x 2125	I	1570	3857
4725 x 2000	I	15666	3772
4725 x 2125	I	15670	3917 ³
4750 x 2000	M	15766	3807
4750 x 2125	M	15770	3933
4750 x 2250	M	15774	4041
4877 x 2000	I	1666	3839
4877 x 2125	I	1670	3993 ¹
5000 x 2000	M	16566	3959
5000 x 2125	M	16570	4064
5000 x 2250	M	16574	4169
5000 x 2375	M	16579	4276
5000 x 2500	M	16582	4378
5500 x 2000	M	18166	4278
5500 x 2125	M	18170	4395
5500 x 2250	M	18174	4505



¹ Available as stock door in Rosewood or Golden Oak timber effect.

² Available as stock door in Rosewood timber effect.

³ Available as stock door in Golden Oak timber effect.

Prices in bold are generally a stock item. Non-bold prices require a longer lead-time.

- I** Imperial door sizes.
- M** Metric door sizes. Extended lead time of 4-6 weeks.

-  Supplied as standard with tension spring gear. Torsion spring fitting available for Premium doors at £120 surcharge.
-  Supplied as standard with torsion spring gear. Low headroom fitting available at £186 surcharge.

Purpose-made sizes available upon request. Non standard colours also available upon request. Doors supplied without locking as standard (see options on page 89 for handles). For window options please see page 64.

Steel Sectional Garage Doors

Linear large design										
Brickwork opening Width x Height (mm x mm)	Size Code	Premium	Premium	Premium	Premium	Surcharge for Standard Colours	Surcharge for Non-Std. Colours	Texture Options		
								Slategrain ¹	Silkgrain ³	Timber Effect / Titan (CH 703)
2080 x 2000	I	61066	1635	2054	2255	2255	255	411		
2080 x 2080	I	610610	1696	2080	2282	2282	266	428		
2134 x 2000	I	7066	1699	2054	2255	2255	262	421		
2134 x 2125	I	7070	1756	2080	2282	2282	278	447		
2250 x 1900	M	7462	1804	2174	2391	2391	262	421		
2250 x 2000	M	7466	1857	2212	2431	2431	276	444		
2250 x 2125	M	7470	1858	2216	2434	2434	294	472		
2286 x 2000	I	7666	1699	2054	2255	2255	280	452		
2286 x 2125	I	7670	1756	2080	2282	2282	298	480		
2286 x 2250	I	7674	1777	2171	2383	2373	316	508		
2286 x 2375	I	7679	1919	2182	2392	2451	333	536		
2286 x 2500	I	7682	1913	2235	2451	2392	351	565		
2375 x 1900	M	7962	1804	2174	2391	2391	277	445		
2375 x 2000	M	7966	1802	2181	2396	2396	292	469		
2375 x 2125	M	7970	1805	2183	2397	2397	309	498		
2375 x 2250	M	7974	1834	2247	2466	2466	328	527		
2438 x 2000	I	8066	1787	2158	2372	2372	299	482		
2438 x 2125	I	8070	1860	2216	2434 ²	2456	318	512		
2438 x 2250	I	8074	1839	2237	2456	2434	336	542		
2438 x 2375	I	8079	1947	2346	2577	2577	355	572		
2438 x 2500	I	8082	1945	2347	2576	2576	374	602		
2500 x 1900	M	8262	1804	2174	2391	2391	292	469		
2500 x 2000	M	8266	1802	2181	2396	2396	306	493		
2500 x 2125	M	8270	1805	2183	2397	2397	326	524		
2500 x 2250	M	8274	1834	2247	2466	2466	346	555		



¹ Silkgrain surface supplied with tension spring gear up to 3048 mm wide.

² Available as stock door in Golden Oak timber effect.

³ Available as stock door in Rosewood or Golden Oak timber effect.

Prices in bold are generally a stock item. Non-bold prices require a longer lead-time.

- I** Imperial door sizes.
- M** Metric door sizes. Extended lead time of 4-6 weeks.

-  Supplied as standard with tension spring gear. Torsion spring fitting available for Premium doors at £120 surcharge.
-  Supplied as standard with torsion spring gear. Low headroom fitting available at £186 surcharge.

Purpose-made sizes available upon request. Non standard colours also available upon request. Doors supplied without locking as standard (see options on page 89 for handles). For window options please see page 64.

For Slategrain models, the door section has a Slategrain texture but the cover profiles and fascia are smooth.

Doors supplied without locking as standard, see options on page 89 for handles. For window options, please see page 64.

Steel Sectional Garage Doors

Linear large design									
Brickwork opening Width x Height (mm x mm)	Size Code	Premium	Premium	Premium	Premium	Surcharge for Standard Colours	Surcharge for Non-Std. Colours	Decorative finishes	
								Slategrain ¹	Silkgrain ³
2500 x 2375	M	8279	1942	2357	2588	2588	364	586	
2500 x 2500	M	8282	1940	2358	2588	2588	383	617	
2500 x 2750	M	8290	2364	-	-	-	421	679	
2591 x 2000	I	8666	1787	2170	2385	2385	318	512	
2591 x 2125	I	8670	1860	2216	2434	2434	338	544	
2625 x 2125	M	8770	2050	2520	2776	2588	343	551	
2740 x 2000	I	9066	1941	2389	2631	2631	336	541	
2740 x 2125	I	9070	2010	2423	2668	2668	358	574	
2750 x 2000	M	9166	2078	2542	2803	2803	337	543	
2750 x 2125	M	9170	2147	2595	2860	2860	358	576	
2750 x 2250	M	9174	2152	2624	3007	3007	380	611	
2750 x 2375	M	9179	2209	2791	3077	3077	401	645	
2750 x 2500	M	9182	2313	2858	3149	3149	421	679	
2896 x 2000	I	9666	2030	2523	2782	2782	355	572	
2896 x 2125	I	9670	2115	2558	2819	2819	377	607	
3000 x 2000	M	91066	2341	2658	2932	2932	367	592	
3000 x 2125	M	91070	2337	2656	2928	2928	391	630	
3000 x 2250	M	91074	2356	2760	3043	3043	414	666	
3000 x 2375	M	91079	2418	2898	3196	3196	437	704	
3000 x 2500	M	91082	2518	2939	3240	3240	460	740	
3000 x 3000	M	910910	3066	3982	4404	4404	551	887	
3048 x 2000	I	1066	1962	2523	2782	2782	374	602	
3048 x 2125	I	1070	2032	2558	2819	2819	398	639	

¹ Silkgrain surface supplied with tension spring gear up to 3048 mm wide.

² Available as stock door in Golden Oak timber effect.

³ Available as stock door in Rosewood or Golden Oak timber effect.

Prices in bold are generally a stock item. Non-bold prices require a longer lead-time.

- I** Imperial door sizes.
- M** Metric door sizes. Extended lead time of 4-6 weeks.

- Supplied as standard with tension spring gear. Torsion spring fitting available for Premium doors at £120 surcharge.
- Supplied as standard with torsion spring gear. Low headroom fitting available at £186 surcharge.





Purpose-made sizes available upon request. Non standard colours also available upon request. Doors supplied without locking as standard (see options on page 89 for handles). For window options please see page 64.

For Slategrain models, the door section has a Slategrain texture but the cover profiles and fascia are smooth.

Doors supplied without locking as standard, see options on page 89 for handles. For window options, please see page 64.

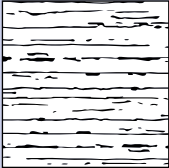
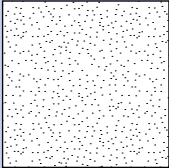
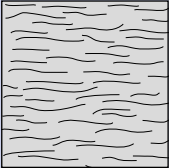
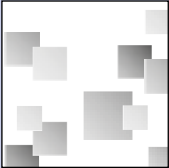
Doors with Duragrain decorative colour finishes Sapeli, Walnut Terra, Moca, Grigio Scurro, Rusty Steel, Burned Oak, Cherry, Rusty Oak and Noce Sorrento Balsamico with a width greater than 4500 mm are supplied as standard with door leaf reinforcements at the factory.

Steel Sectional Garage Doors

Linear large design								
Brickwork opening Width x Height (mm x mm)	Size Code	Size Code					Surcharge for Standard Colours	Surcharge for Non-Std. Colours
			Slategrain ¹	Silkgrain ³	Timber Effect / Titan (CH 703)	Duragrain		
								
			Premium	Premium	Premium	Premium		
4420 x 2000	I	14666	3059	3673	4075	4075	542	872
4420 x 2125	I	14670	3184	3766	4178	4178	576	927
4500 x 2000	M	14966	3125	3692	4095	4095	551	887
4500 x 2125	M	14970	3220	3813	4228	4228	586	944
4500 x 2250	M	14974	3282	3902	4326	4326	621	1000
4572 x 2000	I	1566	3115	3748	4159	4159	561	902
4572 x 2125	I	1570	3242	3809	4227	4227	596	959
4725 x 2000	I	15666	3231	3819	4238	4238	579	932
4725 x 2125	I	15670	3331	3885	4312	4312	616	990
4750 x 2000	M	15766	3221	3853	4276	4276	582	937
4750 x 2125	M	15770	3320	3944	4377	4377	619	995
4750 x 2250	M	15774	3378	4037	4479	4479	655	1055
4877 x 2000	I	1666	3253	3886	4315	4315	598	962
4877 x 2125	I	1670	3381	3957	4392	4392	635	1022
5000 x 2000	M	16566	3322	4006	4448	4479	612	986
5000 x 2125	M	16570	3391	4091	4541	4541	652	1048
5000 x 2250	M	16574	3454	4183	4643	4643	689	1110
5000 x 2375	M	16579	3522	4281	4751	4751	728	1172
5000 x 2500	M	16582	3586	4381	4862	4862	766	1233
5500 x 2000	M	18166	3558	4165	4627	4627	674	1085
5500 x 2125	M	18170	3654	4251	4721	4721	716	1153
5500 x 2250	M	18174	3743	4397	4883	4883	759	1222



¹ Silkgrain surface supplied with tension spring gear up to 3048 mm wide.

² Available as stock door in Golden Oak timber effect.

³ Available as stock door in Rosewood or Golden Oak timber effect.

Prices in bold are generally a stock item. Non-bold prices require a longer lead-time.

- I** Imperial door sizes.
- M** Metric door sizes. Extended lead time of 4-6 weeks.

-  Supplied as standard with tension spring gear. Torsion spring fitting available for Premium doors at £120 surcharge.
-  Supplied as standard with torsion spring gear. Low headroom fitting available at £186 surcharge.

Purpose-made sizes available upon request. Non standard colours also available upon request. Doors supplied without locking as standard (see options on page 89 for handles). For window options please see page 64.

For Slategrain models, the door section has a Slategrain texture but the cover profiles and fascia are smooth.

Doors supplied without locking as standard, see options on page 89 for handles. For window options, please see page 64.

Doors with Duragrain decorative colour finishes Sapeli, Walnut Terra, Moca, Grigio Scurro, Rusty Steel, Burned Oak, Cherry, Rusty Oak and Noce Sorrento Balsamico with a width greater than 4500 mm are supplied as standard with door leaf reinforcements at the factory.

Steel Sectional Garage Doors

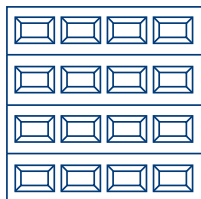

Woodgrain Premium (42 mm insulated)

Georgian design																
Door Height	Door width															
	2000	2250	2375	2500	2750	3000	3250	3500	3750	4000	4250	4500	4750	5000	5250	5500
1900	2131	2141	2175	2370	2583	2782	2962	3239	3287	3354	3445	3523	3612	3685	3789	
2000	2153	2163	2191	2430	2614	2817	3029	3282	3352	3445	3539	3616	3688	3763	3868	
2080	2166	2179	2205	2463	2653	2836	3101	3320	3409	3539	3634	3709	3760	3841	3946	
2125	2166	2179	2205	2463	2653	2836	3101	3320	3409	3539	3634	3709	3760	3841	3946	
2205	2289	2313	2401	2510	2820	2866	3185	3395	3470	3627	3740	3793	3845	3923	4033	
2250	2197	2221	2305	2410	2705	2866	3185	3395	3470	3627	3740	3793	3845	3923	4033	
2375	2224	2264	2334	2460	2758	2942	3242	3466	3538	3685	3830	3895	4047	4130	4246	
2500	2268	2321	2373	2553	2859	3034	3299	3535	3605	3764	3882	3996	4244	4336	4458	
2600	2336	2383	2416	2654	2974	3136	3395	3609	3678	3856	4074	4197	4456	4553	4679	
2750	2512	2567	2577	2906	3164	3222	3449	3677	3836	4023	4250	4382	4654	4758	4891	
2850	2828	2889	3089	3354	3585	3631	3763	3832	4005	4201	4444	4574	4859	4968	-	
3000	3125	3173	3247	3444	3675	3717	3881	3991	4171	4377	4623	4759	5056	-	-	

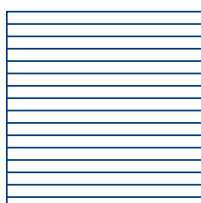

Woodgrain Premium (42 mm insulated)

Linear small design																
Door Height	Door width															
	2000	2250	2375	2500	2750	3000	3250	3500	3750	4000	4250	4500	4750	5000	5250	5500
1900	1594	1645	1691	1894	2128	2262	2449	2456	2562	2673	2776	2871	2971	3132	3250	
2000	1652	1698	1743	1967	2192	2329	2523	2535	2637	2777	2878	2978	3055	3224	3347	
2080	1702	1743	1791	2020	2252	2396	2595	2620	2712	2858	2975	3078	3139	3311	3435	
2125	1702	1743	1791	2020	2252	2396	2595	2620	2712	2858	2975	3078	3139	3311	3435	
2205	1738	1781	1813	2042	2289	2459	2674	2693	2779	2946	3085	3158	3235	3415	3545	
2250	1738	1781	1813	2042	2289	2459	2674	2693	2779	2946	3085	3158	3235	3415	3545	
2375	1775	1822	1845	2088	2330	2518	2727	2768	2853	3028	3189	3280	3408	3595	3732	
2500	1806	1852	1887	2146	2375	2618	2813	2837	2925	3119	3252	3395	3574	3774	3914	
2600	1861	1910	1958	2251	2474	2719	2881	2925	2998	3206	3414	3561	3750	3958	4107	
2750	2042	2099	2160	2502	2753	2816	2960	3001	3126	3351	3562	3718	3916	4132	4288	
2850	2250	2304	2360	2605	2856	2911	3080	3131	3259	3492	3718	3884	4089	4313	-	
3000	2336	2406	2467	2706	2962	3005	3201	3255	3394	3635	3868	4040	4258	-	-	

Supplied with tensions spring as standard. Optional torsion spring available at additional cost, please see page 91.
 These doors are only available with torsion spring.

For further options please see page 89.

Only fixed door heights are available on Georgian Premium sectional doors.

For intermediate heights, between designated heights in the table above please add £161 (for example, a required height of 2175 mm would be taken from the designated height 2205 mm).

Steel Sectional Garage Doors



Woodgrain Premium (42 mm insulated)

Linear medium design																
Door Height	Door width															
	2000	2250	2375	2500	2750	3000	3250	3500	3750	4000	4250	4500	4750	5000	5250	5500
1900	1594	1645	1691	1894	2128	2262	2449	2456	2562	2673	2776	2871	2971	3132	3250	
2000	1652	1698	1743	1967	2192	2329	2523	2535	2637	2777	2878	2978	3055	3224	3347	
2080	1702	1743	1791	2020	2252	2396	2595	2620	2712	2858	2975	3078	3139	3311	3435	
2125	1702	1743	1791	2020	2252	2396	2595	2620	2712	2858	2975	3078	3139	3311	3435	
2205	1738	1781	1813	2042	2289	2459	2674	2693	2779	2946	3085	3158	3235	3415	3545	
2250	1738	1781	1813	2042	2289	2459	2674	2693	2779	2946	3085	3158	3235	3415	3545	
2375	1775	1822	1845	2088	2330	2518	2727	2768	2853	3028	3189	3280	3408	3595	3732	
2500	1806	1852	1887	2146	2375	2618	2813	2837	2925	3119	3252	3395	3574	3774	3914	
2600	1861	1910	1958	2251	2474	2719	2881	2925	2998	3206	3414	3561	3750	3958	4107	
2750	2042	2099	2160	2502	2753	2816	2960	3001	3126	3351	3562	3718	3916	4132	4288	
2850	2250	2304	2360	2605	2856	2911	3080	3131	3259	3492	3718	3884	4089	4313	-	
3000	2336	2406	2467	2706	2962	3005	3201	3255	3394	3635	3868	4040	4258	-	-	

Slategrain Premium (42 mm insulated)

Slategrain Premium (42 mm insulated)																
Door Height	Door width															
	2000	2250	2375	2500	2750	3000	3250	3500	3750	4000	4250	4500	4750	5000	5250	5500
1900	1594	1645	1691	1894	2128	2262	2449	2456	2562	2673	2776	2871	2971	3132	3250	
2000	1652	1698	1743	1967	2192	2329	2523	2535	2637	2777	2878	2978	3055	3224	3347	
2080	1702	1743	1791	2020	2252	2396	2595	2620	2712	2858	2975	3078	3139	3311	3435	
2125	1702	1743	1791	2020	2252	2396	2595	2620	2712	2858	2975	3078	3139	3311	3435	
2205	1738	1781	1813	2042	2289	2459	2674	2693	2779	2946	3085	3158	3235	3415	3545	
2250	1738	1781	1813	2042	2289	2459	2674	2693	2779	2946	3085	3158	3235	3415	3545	
2375	1775	1822	1845	2088	2330	2518	2727	2768	2853	3028	3189	3280	3408	3595	3732	
2500	1806	1852	1887	2146	2375	2618	2813	2837	2925	3119	3252	3395	3574	3774	3914	
2600	1861	1910	1958	2251	2474	2719	2881	2925	2998	3206	3414	3561	3750	3958	4107	
2750	2042	2099	2160	2502	2753	2816	2960	3001	3126	3351	3562	3718	3916	4132	4288	
2850	2250	2304	2360	2605	2856	2911	3080	3131	3259	3492	3718	3884	4089	4313	-	
3000	2336	2406	2467	2706	2962	3005	3201	3255	3394	3635	3868	4040	4258	-	-	

Supplied with tension spring as standard. Optional torsion spring available at additional cost, please see page 91.

These doors are only available with torsion spring.

For further options please see page 89.

For intermediate heights, between designated heights in the table above please add £161 (for example, a required height of 2175 mm would be taken from the designated height 2205 mm).

Steel Sectional Garage Doors



Silkgrain Premium (42 mm insulated)

Linear medium design																
Door Height	Door width															
	2000	2250	2375	2500	2750	3000	3250	3500	3750	4000	4250	4500	4750	5000	5250	5500
1900	1855	1922	1978	2233	2521	2706	2932	2939	3072	3201	3328	3446	3567	3702	3844	
2000	1928	1990	2041	2319	2603	2787	3025	3035	3161	3328	3456	3571	3671	3807	3956	
2080	1996	2043	2100	2382	2674	2864	3109	3132	3246	3429	3568	3690	3768	3912	4064	
2125	1996	2043	2100	2382	2674	2864	3109	3132	3246	3429	3568	3690	3768	3912	4064	
2205	2067	2118	2151	2451	2751	2950	3196	3221	3332	3526	3702	3793	3889	4037	4194	
2250	2067	2118	2151	2451	2751	2950	3165	3221	3332	3526	3702	3793	3889	4037	4194	
2375	2134	2192	2235	2532	2826	3010	3267	3314	3415	3633	3828	3937	4092	4250	4412	
2500	2204	2261	2314	2646	2947	3130	3364	3399	3503	3735	3900	4074	4292	4463	-	
2600	2558	2634	2708	2973	3260	3304	3518	3584	4088	4326	4475	4682	-	-	-	
2750	2569	2646	2720	2984	3272	3315	3529	3596	4099	4338	4486	4694	-	-	-	
2850	2771	2856	2935	3224	3532	3584	3818	3893	4251	4563	4627	-	-	-	-	
3000	2785	2869	2949	3238	3546	3598	3831	3906	4264	4577	4641	-	-	-	-	

Supplied with tensions spring as standard. Optional torsion spring available at additional cost, please see page 91.
 These doors are only available with torsion spring.

For further options please see page 89.

For intermediate heights, between designated heights in the table above please add £161 (for example, a required height of 2175 mm would be taken from the designated height 2205 mm). Duragrain doors are only available in the following colours: Anthracite Grey (RAL 7016) and Traffic White (RAL 9016).

Other colours and RAL to choose are not possible.

For Linear Medium (Silkgrain) models, price available on request for door sizes 4750 mm to 5000 mm width and 2600 mm to 2850 mm height.

For Linear Medium (Silkgrain) models, price available on request for door sizes 5000 mm to 5500 mm width and 2600 mm to 2750 mm height.

Steel Sectional Garage Doors

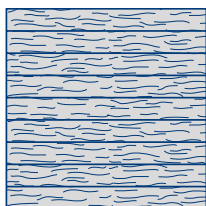

Timber Effect / Titan (CH 703) Premium (42 mm insulated)

Linear medium design																
Door Height	Door width															
	2000	2250	2375	2500	2750	3000	3250	3500	3750	4000	4250	4500	4750	5000	5250	5500
1900	2040	2116	2180	2466	2793	3002	3257	3263	3415	3561	3704	3837	3973	4126	4287	
2000	2120	2189	2246	2562	2881	3090	3358	3369	3513	3702	3845	3976	4089	4243	4409	
2080	2194	2247	2312	2630	2959	3175	3451	3477	3606	3813	3970	4108	4196	4359	4531	
2125	2194	2247	2312	2630	2959	3175	3451	3477	3606	3813	3970	4108	4196	4359	4531	
2205	2272	2329	2367	2706	3044	3270	3548	3576	3702	3921	4119	4222	4332	4498	4674	
2250	2272	2329	2367	2706	3044	3270	3548	3576	3702	3921	4119	4222	4332	4498	4674	
2375	2346	2412	2460	2795	3129	3335	3625	3680	3793	4040	4260	4382	4557	4736	4919	
2500	2424	2488	2547	2923	3262	3470	3734	3774	3890	4153	4340	4536	4782	4975	5171	
2600	2820	2906	2990	3289	3614	3663	3905	3980	4549	4818	4986	5220	5344	5552	5775	
2750	2832	2918	3002	3301	3626	3675	3916	3991	4560	4830	4997	5232	5355	5564	5787	
2850	3058	3152	3243	2531	3917	3976	4240	4324	4728	5081	5155	5393	5689	-	-	
3000	3071	3166	3256	3582	3931	3989	4254	4338	4742	5095	5168	5407	5703	-	-	

Supplied with tension spring as standard. Optional torsion spring available at additional cost, please see page 91.

These doors are only available with torsion spring.

For further options please see page 89.

For intermediate heights, between designated heights in the table above please add £161 (for example, a required height of 2175 mm would be taken from the designated height 2205 mm).

Steel Sectional Garage Doors



Woodgrain Premium (42 mm insulated)

Linear large design																
Door Height	Door width															
	2000	2250	2375	2500	2750	3000	3250	3500	3750	4000	4250	4500	4750	5000	5250	5500
1900	1935	2003	2063	2327	2626	2798	3042	3052	3190	3329	3461	3588	3715	3927	4078	
2000	2006	2065	2120	2411	2705	2883	3133	3148	3280	3461	3590	3719	3818	4035	4191	
2080	2067	2119	2177	2477	2781	2962	3222	3247	3369	3563	3711	3845	3929	4146	4309	
2125	2067	2119	2177	2477	2781	2962	3222	3247	3369	3563	3711	3845	3929	4146	4309	
2205	2107	2162	2205	2502	2809	3042	3314	3345	3454	3668	3848	3946	4042	4277	4449	
2250	2107	2162	2205	2502	2809	3042	3314	3345	3454	3668	3848	3946	4042	4277	4449	
2375	2156	2208	2239	2556	2867	3112	3382	3435	3545	3770	3977	4099	4265	4502	4680	
2500	2186	2247	2296	2626	2923	3236	3491	3525	3633	3883	4059	4243	4478	4730	4914	
2600	2250	2318	2379	2756	3045	3361	3567	3631	3720	3996	4260	4450	4696	4966	5157	
2750	2479	2556	2633	3076	3402	3482	3668	3722	3884	4172	4449	4652	4909	5187	5387	
2850	2748	2817	2889	3203	3531	3596	3818	3884	4050	4349	4646	4858	5127	5418	-	
3000	2850	2944	3026	3333	3664	3719	3970	4042	4218	4534	4833	5056	5338	-	-	

Slategrain Premium (42 mm insulated)

Slategrain Premium (42 mm insulated)																
Door Height	Door width															
	2000	2250	2375	2500	2750	3000	3250	3500	3750	4000	4250	4500	4750	5000	5250	5500
1900	1935	2003	2063	2327	2626	2798	2939	3052	3190	3329	3461	3588	3715	3927	4078	
2000	2006	2065	2120	2411	2705	2883	3133	3148	3280	3461	3590	3719	3818	4035	4191	
2080	2067	2119	2177	2477	2781	2962	3222	3247	3369	3563	3711	3845	3929	4146	4309	
2125	2067	2119	2177	2477	2781	2962	3222	3247	3369	3563	3711	3845	3929	4146	4309	
2205	2107	2162	2205	2502	2809	3042	3314	3345	3454	3668	3848	3946	4042	4277	4449	
2250	2107	2162	2205	2502	2809	3042	3314	3345	3454	3668	3848	3946	4042	4277	4449	
2375	2156	2208	2239	2556	2867	3112	3382	3435	3545	3770	3977	4099	4265	4502	4680	
2500	2186	2247	2296	2626	2923	3236	3491	3525	3633	3883	4059	4243	4478	4730	4914	
2600	2250	2318	2379	2756	3045	3361	3567	3631	3720	3996	4260	4450	4696	4966	5157	
2750	2479	2556	2633	3076	3402	3482	3668	3722	3884	4172	4449	4652	4909	5187	5387	
2850	2748	2817	2889	3203	3531	3596	3818	3884	4050	4349	4646	4858	5127	5418	-	
3000	2850	2944	3026	3333	3664	3719	3970	4042	4218	4534	4833	5056	5338	-	-	

Supplied with tension spring as standard. Optional torsion spring available at additional cost, please see page 91.

These doors are only available with torsion spring.

For further options please see page 89.

For intermediate heights, between designated heights in the table above please add £161 (for example, a required height of 2175 mm would be taken from the designated height 2205 mm).

Steel Sectional Garage Doors



Silkgrain Premium (42 mm insulated)

Linear large design

Door Height	Door width															
	2000	2250	2375	2500	2750	3000	3250	3500	3750	4000	4250	4500	4750	5000	5250	5500
1900	2280	2294	2306	2547	2795	3033	3118	3163	3184	3386	3490	3577	3607	3673	3743	
2000	2316	2320	2337	2615	2895	3137	3212	3271	3429	3516	3605	3802	3833	3905	3979	
2080	2342	2347	2353	2670	2944	3187	3272	3293	3492	3613	3727	3857	3925	3999	4080	
2125	2342	2347	2353	2670	2944	3187	3272	3293	3492	3613	3727	3857	3925	3999	4080	
2205	2386	2409	2440	2806	3095	3248	3322	3372	3597	3694	3829	3952	4016	4092	4171	
2250	2386	2409	2440	2806	3095	3248	3322	3372	3597	3694	3829	3952	4016	4092	4171	
2375	2404	2429	2492	2869	3120	3306	3393	3488	3694	3794	3938	4100	4232	4307	4394	
2500	2419	2469	2553	2935	3167	3356	3443	3548	3764	3880	4050	4205	4437	4517	-	
2600	2593	2654	2750	3229	3421	3527	3598	3733	3998	4150	4426	4594	-	-	-	
2750	2604	2666	2761	3241	3433	3539	3609	3744	4010	4161	4437	4606	-	-	-	
2850	3133	3199	3242	3569	3761	3860	3933	4055	4344	4511	4807	-	-	-	-	
3000	3146	3213	3254	3582	3774	3874	3946	4069	4358	4525	4820	-	-	-	-	

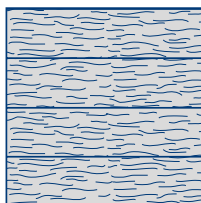

Timber Effect / Titan (CH 703) Premium (42 mm insulated)

Linear large design

Door Height	Door width															
	2000	2250	2375	2500	2750	3000	3250	3500	3750	4000	4250	4500	4750	5000	5250	5500
1900	2483	2497	2512	2778	3054	3316	3412	3461	3484	3708	3824	3919	3954	4027	4104	
2000	2519	2524	2542	2850	3162	3430	3512	3578	3752	3850	3949	4167	4202	4282	4364	
2080	2546	2551	2559	2911	3214	3482	3578	3601	3822	3956	4082	4227	4301	4385	4474	
2125	2546	2551	2559	2911	3214	3482	3578	3601	3822	3956	4082	4227	4301	4385	4474	
2205	2594	2619	2654	3059	3380	3549	3631	3688	3937	4044	4194	4329	4401	4485	4572	
2250	2594	2619	2654	3059	3380	3549	3631	3688	3937	4044	4194	4329	4401	4485	4572	
2375	2612	2640	2710	3127	3407	3612	3709	3814	4042	4153	4313	4492	4639	4722	4818	
2500	2626	2683	2777	3200	3457	3666	3762	3879	4119	4247	4436	4608	4866	4953	5058	
2600	2818	2885	2992	3524	3736	3853	3932	4081	4376	4544	4851	5036	5327	5425	5539	
2750	2830	2896	3003	3535	3747	3864	3943	4093	4388	4556	4862	5048	5338	5436	5550	
2850	3413	3487	3534	3897	4109	4219	4300	4436	4756	4942	5269	5478	5793	-	-	
3000	3426	3500	3548	3910	4123	4233	4314	4450	4770	4955	5282	5491	5807	-	-	

Supplied with tensions spring as standard. Optional torsion spring available at additional cost, please see page 91.

These doors are only available with torsion spring.

For further options please see page 89.

For intermediate heights, between designated heights in the table above please add £161 (for example, a required height of 2175 mm would be taken from the designated height 2205 mm). Duragrain doors are only available in the following colours: Anthracite Grey (RAL 7016) and Traffic White (RAL 9016).

Other colours and RAL to choose are not possible.

For Linear Medium (Silkgrain) models, price available on request for door sizes 4750 mm to 5000 mm width and 2600 mm to 2850 mm height.

For Linear Medium (Silkgrain) models, price available on request for door sizes 5000 mm to 5500 mm width and 2600 mm to 2750 mm height.

Steel Sectional Garage Doors

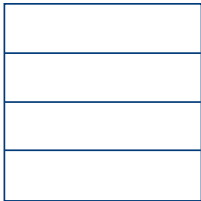

Duragrain Purpose Made

Linear large design

Door Height	Door width															
	2000	2250	2375	2500	2750	3000	3250	3500	3750	4000	4250	4500	4750	5000	5250	5500
1900	2483	2497	2512	2778	3054	3316	3412	3461	3484	3708	3824	3919	3954	4027	4104	
2000	2519	2524	2542	2850	3162	3430	3512	3578	3752	3850	3949	4167	4202	4282	4364	
2080	2546	2551	2559	2911	3214	3482	3578	3601	3822	3956	4082	4227	4301	4385	4474	
2125	2546	2551	2559	2911	3214	3482	3578	3601	3822	3956	4082	4227	4301	4385	4474	
2205	2594	2619	2654	3059	3380	3549	3631	3688	3937	4044	4194	4329	4401	4485	4572	
2250	2594	2619	2654	3059	3380	3549	3631	3688	3937	4044	4194	4329	4401	4485	4572	
2375	2612	2640	2710	3127	3407	3612	3709	3814	4042	4153	4313	4492	4639	4722	4818	
2500	2626	2683	2777	3200	3457	3666	3762	3879	4119	4247	4436	4608	4866	4953	5058	
2600	2818	2885	2992	3524	3736	3853	3932	4081	4376	4544	4851	5036	5327	5425	5539	
2750	2830	2896	3003	3535	3747	3864	3943	4093	4388	4556	4862	5048	5338	5436	5550	
2850	3413	3487	3534	3897	4109	4219	4300	4436	4756	4942	5269	5478	5793	-	-	
3000	3426	3500	3548	3910	4123	4233	4314	4450	4770	4955	5282	5491	5807	-	-	

Supplied with tensions spring as standard. Optional torsion spring available at additional cost, please see page 91.

For intermediate heights, between designated heights in the table above please add £138 (for example, a required height of 2175 mm would be taken from the designated height 2205 mm).

Steel Sectional Garage Doors

Options for sectional doors

	add
Special anchor set (required if you fix the door between brickwork and fasten the frame on the side). If using special anchor set 90 mm cover profiles will be required to cover fixing holes. Two anchor sets are required for doors over 2250 mm high.	80

Please note: Frame legs for brown and any coloured doors come in white as standard, matching cover profiles are available. Silkgrain, Foil Coated Timber Effect and Titan Metallic (CH 703) are available ex-stock. Please however note Colours and RAL to choose must be ordered with the door and cannot be ordered as a spare part at a later time.

Cover Profiles

Door height	White				Standard Colour				RAL to choose				Duragrain		Foil Coated Timber Effect / Titan (CH 703)	
	Woodgrain		Silkgrain		Woodgrain		Silkgrain (Smooth)		Woodgrain		Silkgrain (Smooth)		55	90	55	90
	55	90	55	90	55	90	55	90	55	90	55	90	55	90	55	90
1900	90	124	95	135	104	155	127	160	151	219	157	237	138	174	138	174
2000	95	131	102	143	109	163	133	168	158	230	164	249	145	183	145	183
2080	100	137	106	149	114	169	138	175	165	240	171	260	151	191	151	191
2125	102	139	109	153	116	172	141	179	168	245	174	265	155	194	155	194
2250	108	147	115	162	124	183	149	189	177	260	185	280	164	206	164	206
2375	114	156	121	170	130	195	158	200	188	274	195	296	173	217	173	217
2500	119	164	128	180	137	203	166	211	197	289	206	311	182	228	182	228
3000	-	-	-	-	-	-	-	-	262	411	272	442	-	-	-	-
For door heights not specified above, use formula: door height x price below (i.e. door height 2600 for "White Woodgrain 55": 2.6 x 46 = £119,6)																
	48	65	51	72	55	82	66	84	79	115	82	125	87	137	73	91

Purpose-made width cut-down service (check for size limitations).	91
Cut downs below 2000mm width	714
Purpose-made height cut-down service (check for size limitations).	134
Classic black handle set and lock for on-site installation	92
White finish cast aluminium handle set and lock for on-site installation	203
Brushed stainless steel finish cast aluminium handle set and lock for on-site installation	222
Factory cut hole for handle and lock available with a 2 week increase in lead-time (complete with classic black handle as standard) ¹	144
Standard headroom torsion spring for sectional door less than 4000 mm wide	120
Low headroom tracks arrangement for torsion spring door over 4000 mm wide (when purchased with door)	186

Steel Sectional Garage Doors

ThermoFrame set

ThermoFrame set 4

RM height	up to 3000 mm	3x plastic angle profiles	Length 3210 mm	per set	465
LZ width	up to 3210 mm				

ThermoFrame set 5

RM height	up to 3000 mm	2x plastic angle profiles	Length 3210 mm	per set	465
LZ width	from 3210 mm up to 6000 mm	1x plastic angle profile	Length 6000 mm		

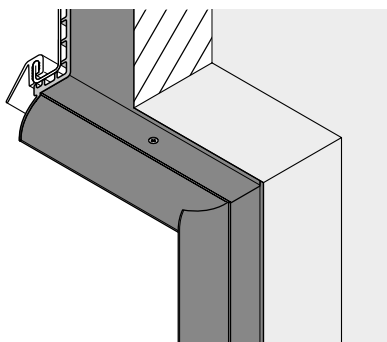

Set consists of

- 3x Plastic angle profiles black 84 x 22.5 mm with lip seal

Note on set 4 and 5 (frame covering not possible):

- A single-skinned fascia panel is fitted. Required headroom corresponds with track application Z, N and L.
- Please also note the supplements and limitations in the technical manual!

Options for sectional doors

Standard colour finish for purpose made sectional doors (i.e. 2000 mm x 2125 mm is an area of 4.25 m ²)	per m ²	62
RAL to choose or CH 703 colour finish for purpose made sectional doors	per m ²	100
Top fascia for sectional doors (95 mm). Woodgrain surface texture (Traffic White RAL 9016)	per m ²	48
Top fascia for sectional doors (95 mm). Duragrain surface texture (Traffic White RAL 9016)	per m ²	53
Top fascia for sectional doors (95 mm). Silkgrain surface texture (Traffic White RAL 9016)	per m ²	53
Top fascia for sectional doors (95 mm). Timber Effect surface texture (Timber Effect and CH 703)	per m ²	76
Top fascia for sectional doors (95 mm). Standard colour finish	per m ²	62
Top fascia for sectional doors (95 mm). RAL to choose or CH 703	per m ²	102

Steel Sectional Garage Doors

Sectional doors up to 4000 mm wide and/ or 2500 mm high (excluding Silkgrain surface finish) and Sectional doors up to 3048 mm wide and/ or 2500 mm high (with Silkgrain surface finish):

These doors come with tension spring fitting. With doors from the Premium range the tension springs can be replaced by torsion springs as an option. Tension springs are suitable for low headroom installations. For a low headroom installation with torsion springs please order low headroom track set separately (changing to a low headroom option is not available as a retrofit).



Sectional garage door with tension spring fitting

Minimum garage dimensions for manually operated doors

Headroom:	100 mm
Sideroom:	90 mm (each side)
Depth into garage:	garage door height + 510 mm
Clear passage height for manually operated doors:	garage door height – 80 mm

Minimum garage dimensions for doors with GaraMatic operator

Headroom	115 mm
Sideroom:	90 mm (each side)
Depth into garage:	for doors up to 2125 mm high: 3200 mm for doors up to 2500 mm high: 3450 mm for doors up to 3000 mm high: 4125 mm

Clear passage height for doors with GaraMatic operator:	garage door height – 30 mm
---	----------------------------

Minimum ceiling height:	115 mm
Minimum ceiling height (with ThermoFrame):	145 mm

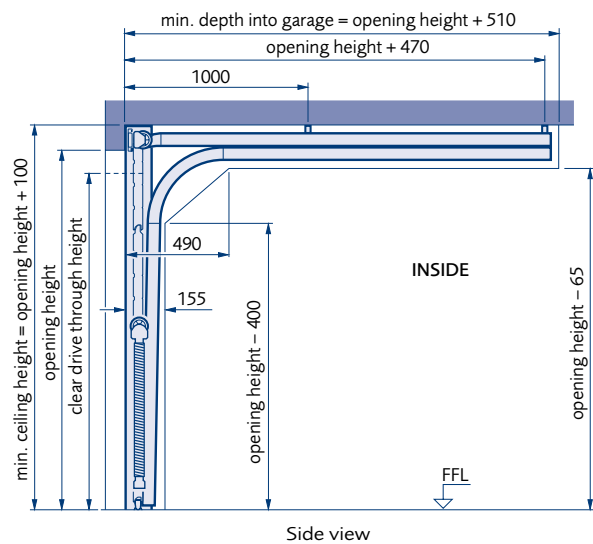

Side view

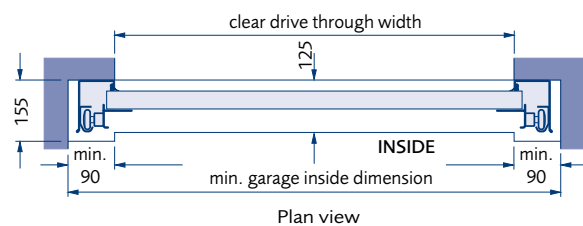

Plan view

Steel Sectional Garage Doors

Sectional doors with torsion spring fitting wider than 4000 mm wide (excluding Silkgrain surface finish) and Sectional doors wider than 3048 mm wide (with Silkgrain surface finish):

These doors come with torsion springs as standard. For a low headroom installation with torsion springs please order low headroom track pack (changing to a low headroom option is not available as a retrofit).



Sectional garage door with torsion spring fitting

Minimum garage dimensions for manually operated doors

Headroom:	210 mm
Sideroom:	90 mm (each side)
Depth into garage:	garage door height + 510 mm
Clear passage height for manually operated doors:	garage door height - 50 mm

Minimum garage dimensions for doors with GaraMatic operator

Headroom:	210 mm
Sideroom:	90 mm (each side)
Depth into garage:	for doors up to 2125 mm high: 3200 mm for doors up to 2500 mm high: 3450 mm for doors up to 3000 mm high: 4125 mm

Minimum ceiling height:	210 mm
Minimum ceiling height (with ThermoFrame):	255 mm

Excludes Silkgrain surface finish.

Torsion spring available for doors over 3000 mm x 2250 mm

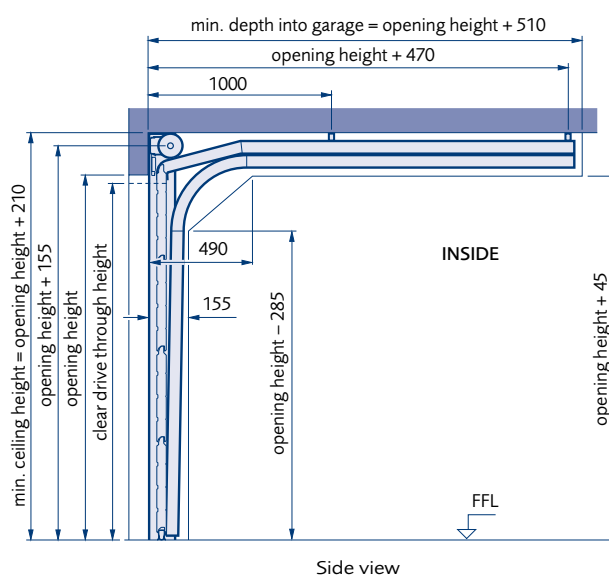

Side view

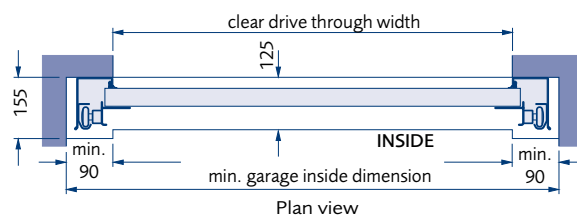

Plan view

Steel Sectional Garage Doors

Sectional doors with low-headroom torsion spring fitting wider than 4000 mm wide (excluding Silkgrain surface finish) and Sectional doors wider than 3048 mm wide (with Silkgrain surface finish):

These doors come with torsion springs as standard. For a low headroom installation with torsion springs please order low headroom track pack (changing to a low headroom option is not available as a retrofit).



Sectional garage door with low headroom torsion spring fitting

Minimum garage dimensions for manually operated doors

Headroom:	100 mm
Sideroom:	90 mm (each side)
Depth into garage:	garage door height + 510 mm
Clear passage height for manually operated doors:	garage door height - 100 mm

Minimum garage dimensions for doors with GaraMatic operator

Headroom:	115 mm
Sideroom:	90 mm (each side)
Depth into garage:	for doors up to 2125 mm high: 3200 mm for doors up to 3000 mm high: 4125 mm

Clear passage height for doors with GaraMatic operator:	for doors up to 3000 mm wide: garage door height - 30 mm for doors wider than 3000 mm: garage door height - 80 mm
---	--

Minimum ceiling height:	115 mm
Minimum ceiling height (with ThermoFrame):	145 mm

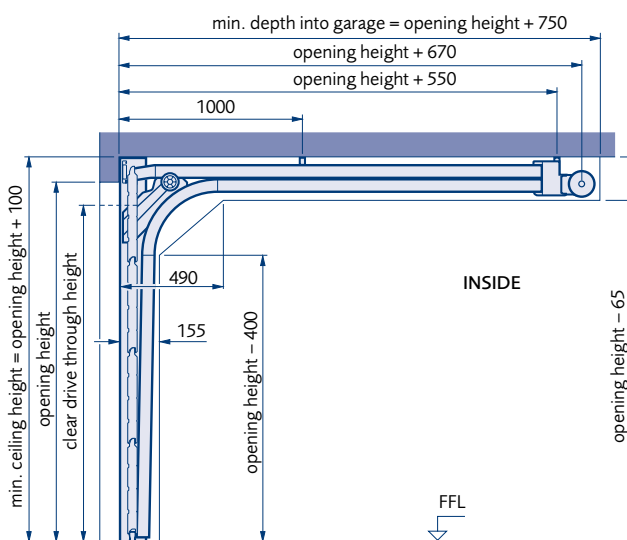

Side view

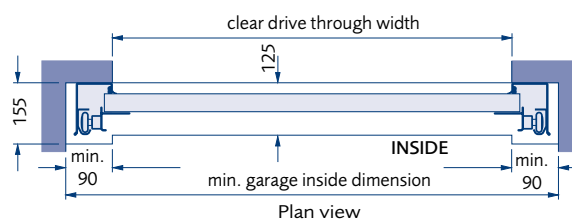

Plan view

Ultra Steel Sectional Garage Doors

Door sections

Made of galvanized steel. Only available as Premium (67 mm thick insulated panel) version. Premium doors are PU-foam insulated (100% CFC-free). Bottom door section comes with floor seal.

Thermal insulation

Door sections have a thermal insulation value of $U = 0.33 \text{ W}/(\text{m}^2 \text{K})$.

The fitted door (without ThermoFrame) has a thermal insulation value of $U = 1.00 \text{ W}/(\text{m}^2 \text{K})$.

The fitted door (with ThermoFrame) has a thermal insulation value of $U = 0.88 \text{ W}/(\text{m}^2 \text{K})$.

Fitting Thermoframe can add up to 15% on the U Value.

Design and surface

Ultra steel sectional garage doors are available in Linear Medium and Linear Large designs only.

Outside: Decograin, Silkgrain with painted colour finish. Inside: pebble texture in Grey White (RAL 9002).

Spring arrangement

- All doors up to 3000 mm wide come with tension springs as standard and torsion springs are available at extra cost.
- All doors over 3001 mm wide come with torsion springs as standard. Low headroom application available at extra cost.
- Tracks, lifting gear and fittings are supplied galvanised as standard. For the painted version, they are in Grey White (RAL 9002).

Side frames & fascia

Sectional doors are designed to be fitted behind the reveals and side frames are supplied white in colour.

Cover profiles are available for use with coloured or foil coated door finishes. A single skin fascia is supplied with all doors which is finished in the same colour as the door sections.

Colours

Steel Silkgrain doors can be ordered in the following RAL colours.

Standard colours available (Silk Gloss):

- Light Ivory (RAL 1015)
- Moss Green (RAL 6005)
- Fir Green (RAL 6009)
- Basalt Grey (RAL 7012)
- Slate Grey (RAL 7015)
- Anthracite Grey (RAL 7016)
- Titan Metallic (CH 703)
- Stone Grey (RAL 7030)
- Light grey (RAL 7035)
- Agate Grey (RAL 7038)
- Quartz Grey (RAL 7039)
- Window Grey (RAL 7040)
- Terra Brown (RAL 8028)
- Jet Black (RAL 9005)
- Chartwell Green (BS 14C35)

Ultra Steel Sectional Garage Doors

Standard colours available (Silk Matt):

- White Aluminum (Silk Matt) (RAL 9006)
- Grey Aluminium (Silk Matt) (RAL 9007)

Timber effect foil coated doors are available in the following two finishes:

Golden Oak and Dark Oak.

Handle and electric automation

Ultra sectional garage doors cannot be fitted with handles and must therefore be electrically operated. For garages with no other personal access, an emergency release kit must be fitted.

Packaging and stock availability

Sectional doors are provided in a palletted format, shrink wrapped for easy handling, and come with a separate gear pack. All sectional doors are made to order and will require 4-6 weeks for delivery.

Gears

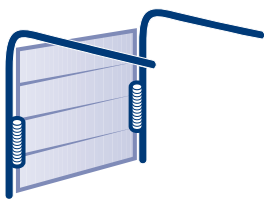

Tension spring

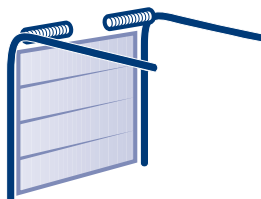

Torsion spring

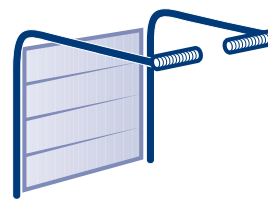

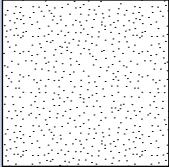
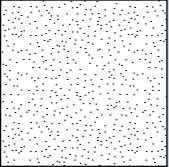
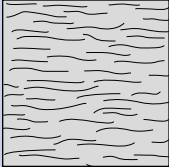

Low headroom torsion spring fitting

Ultra Sectional Garage Doors

Linear medium design						
Brickwork opening Width x Height (mm x mm)	Size Code	  				
		Premium	Premium	Premium		
2190 x 2080	M	7168	2091	2370	2297	
2250 x 1900	M	7462	2021	2284	2223	
2250 x 2000	M	7466	2098	2374	2307	
2250 x 2125	M	7470	2170	2464	2387	
2315 x 2080	M	7666	2167	2463	2384	
2315 x 2205	M	7670	2246	2560	2471	
2375 x 1900	M	7962	2095	2372	2307	
2375 x 2000	M	7966	2166	2458	2385	
2375 x 2125	M	7970	2221	2531	2446	
2375 x 2250	M	7974	2307	2635	2539	
2440 x 2080	M	80610	2236	2547	2461	
2440 x 2205	M	8072	2292	2622	2521	
2500 x 1900	M	8262	2159	2451	2380	
2500 x 2000	M	8266	2224	2531	2451	
2500 x 2125	M	8270	2291	2617	2522	
2500 x 2250	M	8274	2345	2689	2582	
2500 x 2375	M	8279	2436	2801	2683	
2500 x 2500	M	8282	2522	2905	2779	
2625 x 2125	M	8770	2449	2791	2701	
2750 x 2000	M	9166	2533	2870	2798	
2750 x 2125	M	9170	2605	2963	2877	
2750 x 2250	M	9174	2679	3059	2958	
2750 x 2375	M	9179	2843	3244	3142	
2750 x 2500	M	9182	2972	3393	3285	
3000 x 2125	M	91070	3003	3394	3326	
3000 x 2250	M	91074	3090	3504	3422	
3000 x 2375	M	91079	3172	3609	3513	
3000 x 2500	M	91082	3305	3765	3660	
3000 x 3000	M	910910	3891	4443	4313	
3250 x 2000	M	10866	3057	3456	3389	
3250 x 2125	M	10870	3139	3562	3479	
3250 x 2250	M	10874	3235	3684	3585	
3500 x 2000	M	11666	3321	3749	3686	

Prices in bold are generally a stock item. Non-bold prices require a longer lead-time.

- I** Imperial door sizes.
- M** Metric door sizes. Extended lead time of 4-6 weeks.

-  Supplied as standard with tension spring gear. Torsion spring fitting available for Premium doors at £120 surcharge.
-  Supplied as standard with torsion spring gear. Low headroom fitting available at £186 surcharge.

RAL to choose or CH 703 colour finish for purpose made sectional doors per m² £100.

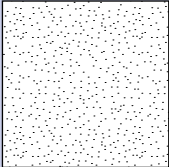
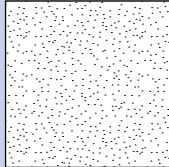
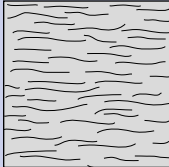

Purpose-made sizes available upon request. Non standard colours also available upon request. Doors supplied without locking as standard (see options on page 89 for handles). For window options please see page 102.

Ultra Sectional Garage Doors

Linear medium design						
Brickwork opening Width x Height (mm x mm)	Size Code	  				
		Premium	Premium	Premium		
3500 x 2125	M	11670	3415	3871	3791	
3500 x 2250	M	11674	3511	3993	3896	
3750 x 2000	M	12466	3332	3792	3698	
3750 x 2125	M	12470	3440	3929	3819	
3750 x 2250	M	12474	3538	4054	3926	
4000 x 2000	M	13266	3475	3965	3859	
4000 x 2125	M	13270	3569	4090	3963	
4000 x 2250	M	13274	3662	4213	4067	
4250 x 2000	M	131166	3662	4183	4071	
4250 x 2125	M	131170	3772	4325	4194	
4250 x 2250	M	131174	3881	4468	4313	
4500 x 2000	M	14966	3803	4354	4229	
4500 x 2125	M	14970	3928	4514	4368	
4500 x 2250	M	14974	4071	4692	4528	
4750 x 2000	M	15766	3932	4514	4375	
4750 x 2125	M	15770	4061	4679	4518	
4750 x 2250	M	15774	4178	4833	4648	
5000 x 2000	M	16566	4041	4653	4498	
5000 x 2125	M	16570	4153	4804	4622	
5000 x 2250	M	16574	4283	4972	4766	
5000 x 2375	M	16579	4509	5237	5020	
5000 x 2500	M	16582	4730	5496	5267	
5500 x 2000	M	18166	4333	5006	4827	
5500 x 2125	M	18170	4451	5167	4957	
5500 x 2250	M	18174	4591	5350	5114	

Prices in bold are generally a stock item. Non-bold prices require a longer lead-time.

- I** Imperial door sizes.
- M** Metric door sizes. Extended lead time of 4-6 weeks.

-  Supplied as standard with tension spring gear. Torsion spring fitting available for Premium doors at £120 surcharge.
-  Supplied as standard with torsion spring gear. Low headroom fitting available at £186 surcharge.

RAL to choose or CH 703 colour finish for purpose made sectional doors per m² £100.

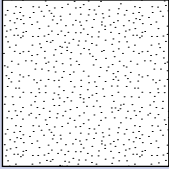
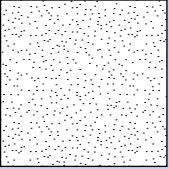
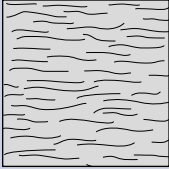

Purpose-made sizes available upon request. Non standard colours also available upon request. Doors supplied without locking as standard (see options on page 89 for handles). For window options please see page 102.

Ultra Sectional Garage Doors

Linear large design					
Brickwork opening Width x Height (mm x mm)	Size Code	  			
		Premium	Premium	Premium	Premium
2190 x 2080	M	7168	2457	2736	2668
2250 x 1900	M	7462	2492	2755	2711
2250 x 2000	M	7466	2530	2806	2750
2250 x 2125	M	7470	2556	2849	2777
2315 x 2080	M	7666	2553	2849	2774
2315 x 2205	M	7670	2600	2914	2824
2375 x 1900	M	7962	2508	2785	2728
2375 x 2000	M	7966	2536	2828	2756
2375 x 2125	M	7970	2561	2870	2783
2375 x 2250	M	7974	2628	2956	2856
2440 x 2080	M	80610	2559	2870	2781
2440 x 2205	M	8072	2622	2952	2847
2500 x 1900	M	8262	2521	2813	2743
2500 x 2000	M	8266	2550	2857	2772
2500 x 2125	M	8270	2568	2894	2790
2500 x 2250	M	8274	2667	3011	2897
2500 x 2375	M	8279	2722	3086	2957
2500 x 2500	M	8282	2786	3169	3027
2625 x 2125	M	8770	2744	3087	2985
2750 x 2000	M	9166	2860	3197	3115
2750 x 2125	M	9170	2922	3280	3183
2750 x 2250	M	9174	3071	3451	3345
2750 x 2375	M	9179	3213	3613	3500
2750 x 2500	M	9182	3285	3707	3579
3000 x 2125	M	91070	3298	3689	3597
3000 x 2250	M	91074	3466	3880	3781
3000 x 2375	M	91079	3491	3928	3807
3000 x 2500	M	91082	3544	4004	3864
3000 x 3000	M	910910	4139	4690	4515
3250 x 2000	M	10866	3443	3842	3760
3250 x 2125	M	10870	3499	3923	3820
3250 x 2250	M	10874	3563	4012	3889
3500 x 2000	M	11666	3525	3954	3850
3500 x 2125	M	11670	3594	4049	3924

Prices in bold are generally a stock item. Non-bold prices require a longer lead-time.

- I** Imperial door sizes.
- M** Metric door sizes. Extended lead time of 4-6 weeks.

-  Supplied as standard with tension spring gear. Torsion spring fitting available for Premium doors at £120 surcharge.
-  Supplied as standard with torsion spring gear. Low headroom fitting available at £186 surcharge.

RAL to choose or CH 703 colour finish for purpose made sectional doors per m² £100.

Purpose-made sizes available upon request. Non standard colours also available upon request. Doors supplied without locking as standard (see options on page 89 for handles). For window options please see page 102.

Ultra Sectional Garage Doors

Linear large design

Brickwork opening Width x Height (mm x mm)	Size Code	Premium			
		White Silkgrain	Std Colour Silkgrain	Decograin	
3500 x 2250	M	11674	3645	4128	3981
3750 x 2000	M	12466	3595	4054	3927
3750 x 2125	M	12470	3613	4102	3945
3750 x 2250	M	12474	3703	4219	4043
4000 x 2000	M	13266	3769	4259	4120
4000 x 2125	M	13270	3841	4362	4198
4000 x 2250	M	13274	3955	4506	4321
4250 x 2000	M	131166	3868	4389	4229
4250 x 2125	M	131170	3972	4526	4343
4250 x 2250	M	131174	4063	4649	4442
4500 x 2000	M	14966	3964	4515	4336
4500 x 2125	M	14970	4099	4686	4483
4500 x 2250	M	14974	4210	4831	4604
4750 x 2000	M	15766	4184	4766	4579
4750 x 2125	M	15770	4246	4865	4646
4750 x 2250	M	15774	4346	5001	4754
5000 x 2000	M	16566	4221	4833	4619
5000 x 2125	M	16570	4320	4971	4727
5000 x 2250	M	16574	4421	5110	4837
5000 x 2375	M	16579	4654	5382	5095
5000 x 2500	M	16582	4887	5653	5350
5500 x 2000	M	18166	4294	4968	4701
5500 x 2125	M	18170	4396	5112	4811
5500 x 2250	M	18174	4498	5256	4922

Prices in bold are generally a stock item. Non-bold prices require a longer lead-time.



Imperial door sizes.

Metric door sizes. Extended lead time of 4-6 weeks.



Supplied as standard with tension spring gear. Torsion spring fitting available for Premium doors at £120 surcharge.

Supplied as standard with torsion spring gear. Low headroom fitting available at £186 surcharge.

RAL to choose or CH 703 colour finish for purpose made sectional doors per m² £100.

Purpose-made sizes available upon request. Non standard colours also available upon request. Doors supplied without locking as standard (see options on page 89 for handles). For window options please see page 102.

Ultra Steel Sectional Garage Doors

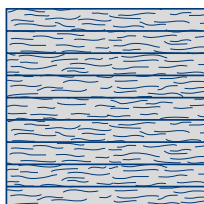

Timber Effect Ultra (67 mm insulated)

Linear medium design																
Door Height	Door width															
	2000	2250	2375	2500	2750	3000	3250	3500	3750	4000	4250	4500	4750	5000	5250	5500
1900	2448	2542	2625	2981	3390	3649	3970	3980	4171	4350	4531	4699	4869	5046	5228	
2000	2540	2628	2702	3091	3498	3758	4091	4105	4286	4522	4701	4864	5005	5185	5373	
2080	2628	2693	2781	3180	3588	3857	4206	4238	4400	4660	4856	5026	5139	5325	5519	
2125	2628	2693	2781	3180	3684	3857	4206	4238	4400	4660	4856	5026	5139	5325	5519	
2205	2723	2797	2845	3269	3790	3972	4324	4356	4515	4792	5035	5169	5303	5492	5691	
2250	2723	2797	2845	3269	3790	3972	4324	4356	4515	4792	5035	5169	5303	5492	5691	
2375	2814	2898	2955	3473	3889	4052	4415	4483	4625	4936	5210	5362	5585	5786	5998	
2500	2905	2986	3063	3632	4055	4215	4549	4597	4747	5072	5304	5554	5861	6073	6293	
2600	3164	3259	3348	3822	4236	4345	4664	4733	5167	5500	5719	5989	6222	6446	6682	
2750	3409	3520	3621	3997	4402	4463	4766	4858	5574	5917	6120	6412	6568	6806	7056	
2850	3557	3675	3780	4170	4594	4661	4975	5074	5686	6033	6244	6522	6680	6921	-	
3000	3702	3823	3936	4341	4780	4851	5181	5283	5793	6148	6328	6626	6787	-	-	

Supplied with tensions spring as standard. Optional torsion spring available at additional cost, please see page 89.
 These doors are only available with torsion spring.
 For further options please see pages 103-105.

RAL to choose or CH 703 colour finish for purpose made sectional doors per m² £100.

Ultra sectional garage doors must be electrically operated with a GaraMatic 10 or GaraMatic 20 operator. A GaraMatic 9 operator is not suitable.



Silkgrain Ultra (67 mm insulated)

Linear medium design																
Door Height	Door width															
	2000	2250	2375	2500	2750	3000	3250	3500	3750	4000	4250	4500	4750	5000	5250	5500
1900	2138	2219	2290	2594	2944	3165	3440	3448	3611	3764	3919	4062	4208	4359	4515	
2000	2220	2295	2358	2691	3038	3260	3545	3557	3712	3913	4067	4207	4327	4480	4641	
2080	2297	2352	2427	2768	3118	3347	3646	3673	3811	4033	4200	4346	4443	4602	4767	
2125	2297	2352	2427	2768	3199	3347	3646	3673	3811	4033	4200	4346	4443	4602	4767	
2205	2379	2443	2483	2846	3291	3448	3748	3776	3911	4148	4356	4470	4585	4746	4917	
2250	2379	2443	2483	2846	3291	3448	3748	23776	3911	4148	4356	4470	4585	4746	4917	
2375	2459	2531	2580	3022	3378	3517	3827	3885	4007	4273	4506	4637	4827	4999	-	
2500	2539	2608	2673	3160	3521	3658	3942	3985	4112	4390	4589	4802	5064	-	-	
2600	2762	2844	2919	3324	3678	3772	4044	4103	4474	4759	4946	5177	-	-	-	
2750	2973	3067	3154	3476	3822	3874	4133	4211	4823	5116	5290	5539	-	-	-	
2850	3101	3202	3292	3625	3987	4045	4314	4398	4921	5218	5397	-	-	-	-	
3000	3226	3330	3426	3773	4148	4208	4490	4578	5014	5317	-	-	-	-	-	

Ultra Sectional Doors

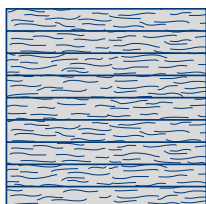

Timber Effect Ultra (67 mm insulated)

Linear large design																
Door Height	Door width															
	2000	2250	2375	2500	2750	3000	3250	3500	3750	4000	4250	4500	4750	5000	5250	5500
1900	2996	3014	3033	3365	3710	4040	4154	4219	4246	4529	4673	4792	4836	4878	4921	
2000	3035	3043	3064	3448	3836	4173	4276	4361	4579	4700	4823	5095	5140	5187	5233	
2080	3067	3072	3082	3522	3899	4238	4356	4382	4664	4829	4986	5168	5261	5307	5354	
2125	3067	3072	3082	3522	3988	4238	4356	4382	4664	4829	4986	5168	5261	5307	5354	
2205	3122	3152	3200	3704	4196	4316	4419	4489	4801	4936	5119	5290	5380	5429	5478	
2250	3122	3152	3200	3704	4196	4316	4419	4489	4801	4936	5119	5290	5380	5429	5478	
2375	3140	3174	3266	3877	4223	4390	4508	4645	4927	5063	5267	5490	5670	5719	5769	
2500	3157	3229	3342	3962	4284	4456	4573	4719	5021	5185	5416	5630	5952	6007	6063	
2600	3285	3362	3486	4130	4422	4582	4690	4856	5190	5379	5686	5908	6253	6310	6367	
2750	3400	3484	3615	4285	4546	4694	4793	4979	5347	5556	5939	6176	6538	6598	6659	
2850	3772	3860	3954	4516	4781	4922	5026	5202	5584	5806	6206	6447	6830	6892	-	
3000	4139	4232	4291	4744	5008	5143	5251	5421	5818	6049	6461	6717	7118	-	-	

Supplied with tensions spring as standard. Optional torsion spring available at additional cost, please see page 89.
 These doors are only available with torsion spring.
 For further options please see pages 103-105.

RAL to choose or CH 703 colour finish for purpose made sectional doors per m² £100.

Ultra sectional garage doors must be electrically operated with a GaraMatic 10 or GaraMatic 20 operator. A GaraMatic 9 operator is not suitable.



Silkgrain Ultra (67 mm insulated)

Linear large design																
Door Height	Door width															
	2000	2250	2375	2500	2750	3000	3250	3500	3750	4000	4250	4500	4750	5000	5250	5500
1900	2751	2767	2784	3085	3396	3694	3797	3857	3881	4136	4267	4375	4415	4452	4491	
2000	2788	2796	2814	3162	3513	3818	3910	3987	4184	4293	4404	4651	4692	4734	4776	
2080	2818	2823	2832	3230	3571	3878	3985	4008	4262	4412	4554	4719	4802	4844	4887	
2125	2818	2823	2832	3230	3652	3878	3985	4008	4262	4412	4554	4719	4802	4844	4887	
2205	2870	2897	2940	3395	3841	3950	4042	4106	4388	4510	4676	4830	4912	4955	5000	
2250	2870	2897	2940	3395	3841	3950	4042	4106	4388	4510	4676	4830	4912	4955	5000	
2375	2888	2919	3001	3553	3866	4018	4125	4249	4504	4626	4810	5014	5174	5220	-	
2500	2903	2969	3071	3632	3924	4079	4185	4317	4589	4833	4948	5140	5433	-	-	
2600	3022	3092	3203	3787	4050	4195	4293	4443	4745	4916	5193	5394	-	-	-	
2750	3127	3203	3322	3928	4164	4297	4387	4556	4888	5078	5425	5637	-	-	-	
2850	3465	3545	3630	4139	4377	4506	4599	4759	5105	5304	5666	-	-	-	-	
3000	3798	3882	3936	4345	4585	4706	4805	4959	5317	5526	-	-	-	-	-	

Window options

Linear medium design



Prices £ stated per window Window frames white as standard	Standard	Cross	Diamond	Linear 1	Linear 2	Linear 3
Premium - Silkgrain ¹	433	465	465	326	357	414
Premium - Timber effect ²	491	549	549	370	401	458

Linear large design

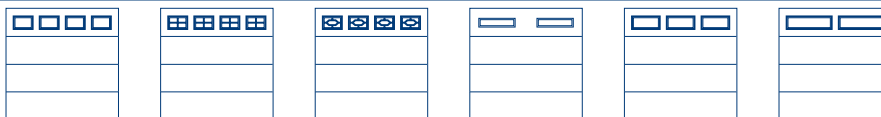

Prices £ stated per window Window frames white as standard	Standard	Cross	Diamond	Linear 1	Linear 2	Linear 3
Premium - Silkgrain ¹	433	465	465	326	357	414
Premium - Timber effect ²	491	549	549	370	401	458

¹ Colours available at surcharge (£44 for standard colour, £73 for non-standard colour, £134 for special RAL colour).

² Windows are painted in a colour to best match the foil coat (colour included in the price).

Standard = S0, Cross = S1, Diamond = S2, Linear 1 = Type D, Linear 2 = Type M0, Linear 3 = Type L0.

Ultra Steel Sectional Garage Doors

Ultra sectional doors (Silkgrain) up to 3000 mm wide and / or 2625 mm high:

Ultra sectional doors (Timber Effect) up to 4000 mm wide and / or 2625 mm high:

These doors come with tension spring fitting. With doors from the Premium range the tension springs can be replaced by torsion springs as an option. Tension springs are suitable for low headroom installations. For a low headroom installation with torsion springs please order low headroom track set separately (changing to a low headroom option is not available as a retrofit).



Sectional garage door with tension spring fitting

Minimum garage dimensions for doors with GaraMatic operator

Headroom:	115 mm
Sideroom:	90 mm (each side)
Depth into garage:	garage door height + 510 mm
Clear passage height for doors with GaraMatic operator:	garage door height - 55 mm
Minimum ceiling height:	115 mm
Minimum ceiling height (with ThermoFrame):	145 mm

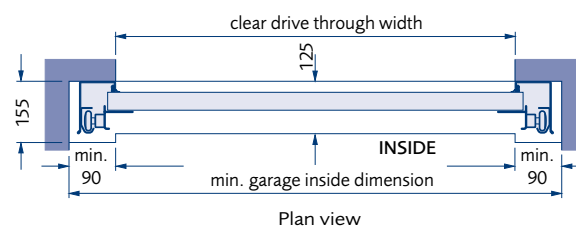
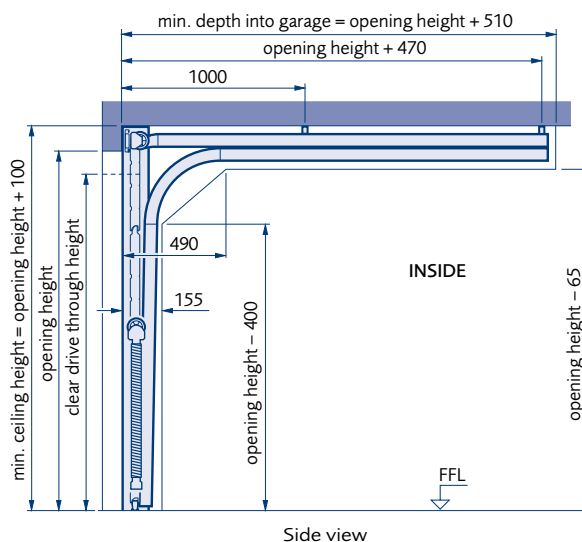

Ultra Steel Sectional Garage Doors

Ultra sectional doors (Silkgrain) wider than 3000 mm wide and / or 2625 mm high:
Ultra sectional doors (Timber Effect) wider than 4000 mm wide and / or 2625 mm high:

These doors come with torsion springs as standard. For a low headroom installation with torsion springs please order low headroom track pack (changing to a low headroom option is not available as a retrofit).



Sectional garage door with torsion spring fitting

Minimum garage dimensions for doors with GaraMatic operator

Headroom: 210 mm
 Sideroom: 90 mm (each side)
 Depth into garage: garage door height + 510 mm
 Clear passage height for manually operated doors: garage door height -

Minimum ceiling height: 210 mm
 Minimum ceiling height (with ThermoFrame): 255 mm

For doors under thermal loads, the operator is to be fitted 40 mm higher if applicable.

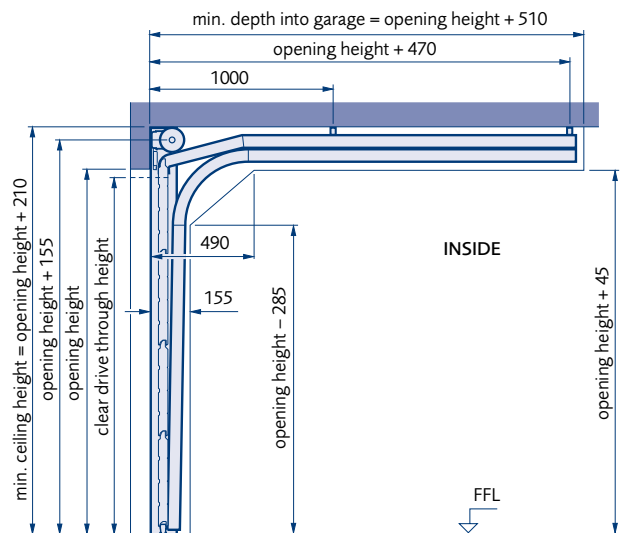

Side view

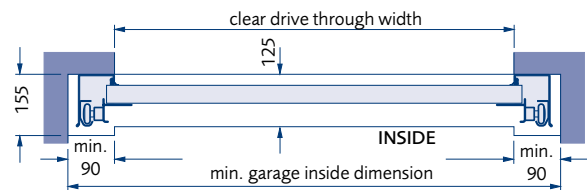

Plan view

Ultra Steel Sectional Garage Doors

Ultra sectional doors (Silkgrain) wider than 3000 mm wide and / or 2625 mm high:

Ultra sectional doors (Timber Effect) wider than 4000 mm wide and / or 2625 mm high:

These doors come with torsion springs as standard. For a low headroom installation with torsion springs please order low headroom track pack (changing to a low headroom option is not available as a retrofit).

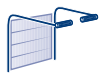

Sectional garage door with low headroom torsion spring fitting

Minimum garage dimensions for doors with GaraMatic operator

Headroom:	115 mm
Sideroom:	90 mm (each side)
Depth into garage:	for doors up to 2125 mm high: 3200 mm for doors up to 3000 mm high: 4125 mm
Clear passage height for doors with GaraMatic operator:	For doors up to 3000 mm wide: garage door height - 55 mm for doors wider than 3000 mm: garage door height - 105 mm
Minimum ceiling height:	115 mm
Minimum ceiling height (with ThermoFrame):	145 mm

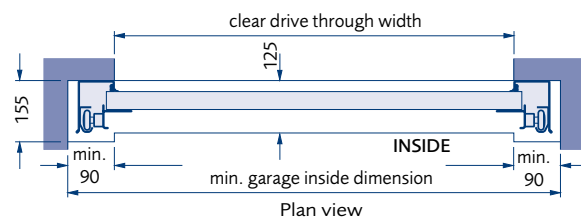
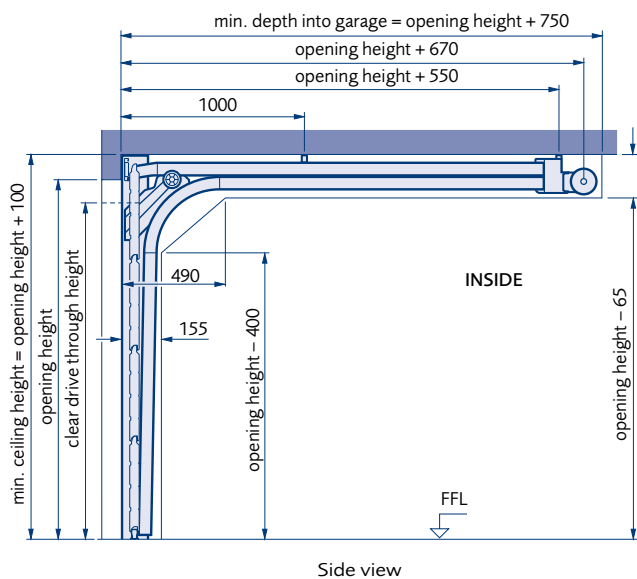

Side Hinged Garage Doors

Door sections

Garage side doors are constructed from aluminium and steel. They are 42 mm thick and have a PU-foam infill (100% CFC-free).

Surface

Outside: Woodgrain, Slategrain, Duragrain, Silkgrain or Timber Effect textures only available in a foil coated finish.

Inside: Pebble texture (Grey White RAL 9002).

Frames

Only available with block frame (profile type 2) only.

Colours

Steel Woodgrain, Slategrain and Silkgrain doors can be ordered in almost any colour from the RAL colour chart. Slategrain surface texture only available in standard RAL colours and Traffic White (RAL 9016).

Standard colours available (Silk Gloss):

- Light Ivory (RAL 1015)
- Moss Green (RAL 6005)
- Fir Green (RAL 6009)
- Basalt Grey (RAL 7012)
- Slate Grey (RAL 7015)
- Anthracite Grey (RAL 7016)
- Titan Metallic (CH 703)
- Stone Grey (RAL 7030)
- Light grey (RAL 7035)
- Agate Grey (RAL 7038)
- Quartz Grey (RAL 7039)
- Window Grey (RAL 7040)
- Terra Brown (RAL 8028)
- Jet Black (RAL 9005)
- Chartwell Green (BS 14C35)

Standard colours available (Silk Matt):

- White Aluminum (Silk Matt) (RAL 9006)
- Grey Aluminium (Silk Matt) (RAL 9007)

Timber effect foil coated doors are available in the following five finishes:

Golden Oak, Dark Oak, Night Oak, Rosewood and Winchester Oak. Foil coated finish also available in Titan Metallic (CH 703) for Linear Medium and Linear Large doors only. Decopaint colour finish not available.

Side Hinged Garage Doors

Duragrain standard colour finishes are:

Standard colours are:

- Concrete
- Grigio Scuro
- Cherry
- Noce Sorrento Balsamico
- Teak
- White Brushed
- Beige
- Nature Oak
- Rusty Steel
- Noce Sorrento Nature
- Used Look
- White Oak
- Mocca
- Bamboo
- Pine
- Sapele
- Terra Walnut
- White Oiled Oak
- Grigio
- Burned Oak
- Rusty Oak
- Sheffield
- Colonial Walnut
- White Washed Oak
- Burned Oak
- Spruce
- Malt Oak

Handle

Sectional side hinged doors are supplied complete with black plastic lever / lever handle as standard.

Premium side hinged

Premium side hinged doors are supplied complete with hinges in a choice of either black, white or aluminium finish at no extra charge.

Handing

For all premium side hinged doors, the door is viewed from the outside looking in.

Installation

Premium side hinged doors are designed for fitting between the opening, opening outwards and inwards.

Packaging

Sectional garage side doors are packed with polystyrene around the door and then shrink wrapped.

Stock availability

Premium side hinged garage doors are made to order and requires approximately 6 weeks lead-time. Contact sales office for further details.

Premium Side Hinged

Linear small design (block frame)

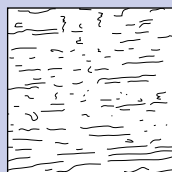
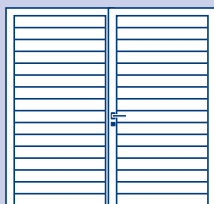

Woodgrain - White Finish



Woodgrain - Standard Colour



Premium



Premium

Overall Frame Dimensions
Width x Height
(mm x mm)

1330 - 2000	x	1800 - 2145	3673	4195
1330 - 2000	x	2146 - 2558	3705	4226
2001 - 3000	x	1800 - 2145	3737	4258
2001 - 3000	x	2146 - 2558	3802	4323

Premium Side Hinged

Linear medium design (block frame)

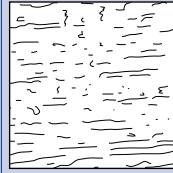
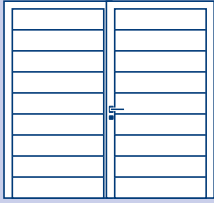

Woodgrain -
White Finish



Premium

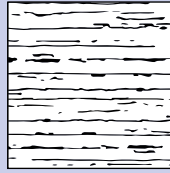

Slategrain -
White Finish



Premium

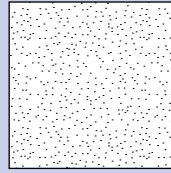

Silkgrain -
White Finish



Premium

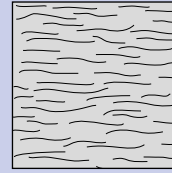

Timber Effect



Premium

Overall Frame Dimensions
Width x Height
(mm x mm)

1330 - 2000	x	1800 - 2145	3673	3673	3931	4295
1330 - 2000	x	2146 - 2558	3705	3705	3962	4325
2001 - 3000	x	1800 - 2145	3737	3737	3998	4371
2001 - 3000	x	2146 - 2558	3802	3802	4070	4446

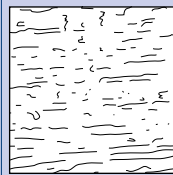
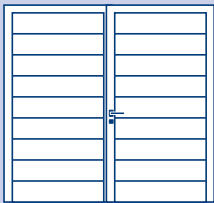

Woodgrain -
Standard Colour



Premium

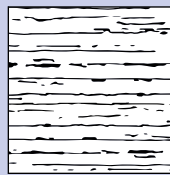

Slategrain -
Standard Colour



Premium

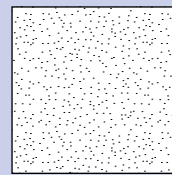

Silkgrain -
Standard Colour



Premium

Overall Frame Dimensions
Width x Height
(mm x mm)

1330 - 2000	x	1800 - 2145	4195	4195	4452
1330 - 2000	x	2146 - 2558	4226	4226	4483
2001 - 3000	x	1800 - 2145	4258	4258	4519
2001 - 3000	x	2146 - 2558	4323	4323	4591

Premium Side Hinged

Linear large design (block frame)

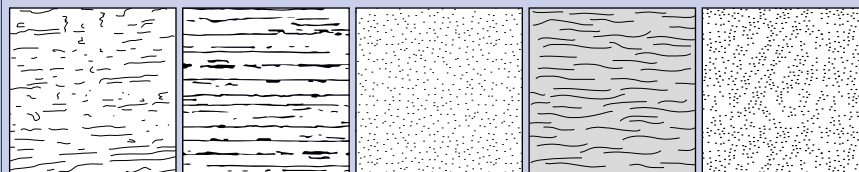
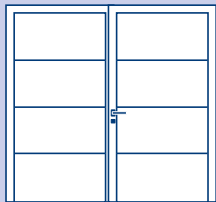

Woodgrain -
White Finish

Slategrain -
White Finish

Silkgrain -
White Finish

Timber Effect

Duragrain



Premium

Premium

Premium

Premium

Premium

Overall Frame Dimensions
Width x Height
(mm x mm)

1330 - 2000	x	1800 - 2145	3797	3797	4063	4437	4437
1330 - 2000	x	2146 - 2558	3831	3831	4093	4475	4475
2001 - 3000	x	1800 - 2145	3862	3862	4132	4518	4518
2001 - 3000	x	2146 - 2558	3933	3933	4201	4597	4597

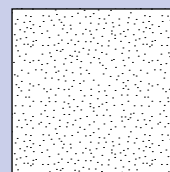
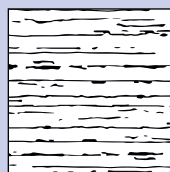
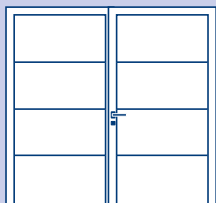

Woodgrain -
Standard Colour

Slategrain -
Standard Colour

Silkgrain -
Standard Colour



Premium

Premium

Premium

Overall Frame Dimensions
Width x Height
(mm x mm)

1330 - 2000	x	1800 - 2145	4318	4318	4584
1330 - 2000	x	2146 - 2558	4352	4352	4614
2001 - 3000	x	1800 - 2145	4383	4383	4653
2001 - 3000	x	2146 - 2558	4454	4454	4722

Side Hinged Garage Doors

Side hinged door fitting dimensions – block frame (profile type 2) – opening outwards

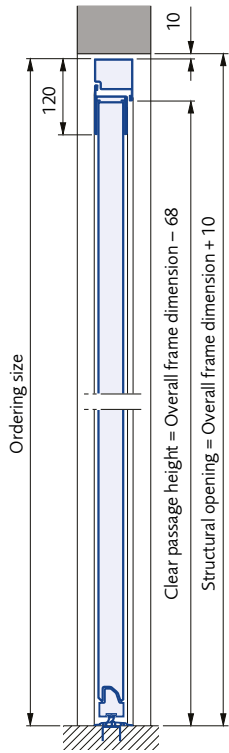

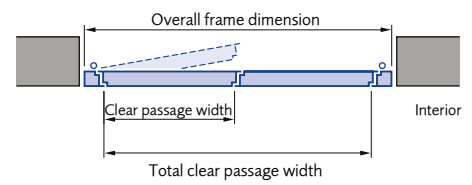
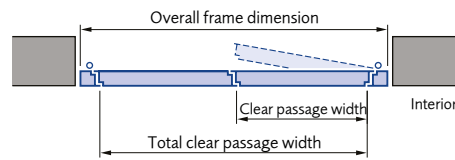
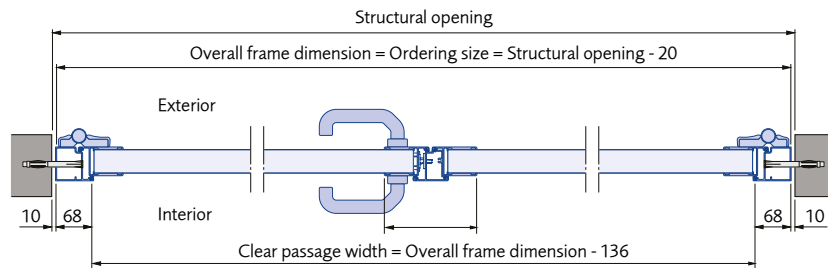

Profile 2: Only opening outwards

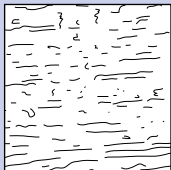
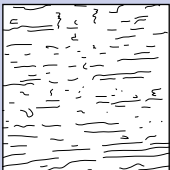

Premium Side Doors

Linear small design (corner frame)

					
		Woodgrain - White	Woodgrain - Standard Colour		
Overall Frame Dimensions Width x Height (mm x mm)					
		Premium	Premium		
875	x	2000	1367	1628	Profile Type 1 & 2
875	x	2125	1367	1628	
1000	x	2000	1416	1676	
1000	x	2125	1416	1676	
875 - 1200		x	1800 - 2100	1693	1954
1201 - 1284		x	2101 - 2500	1737	1997

Profile 1: Only opening inwards

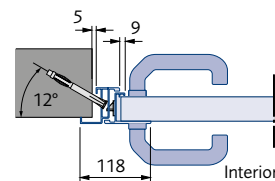

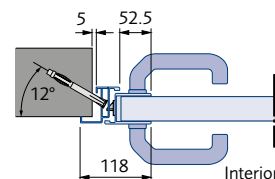

Profile 2: Opening inwards

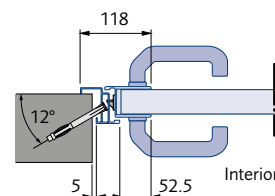

Profile 2: Opening outwards

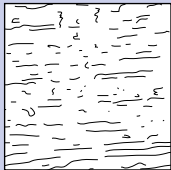
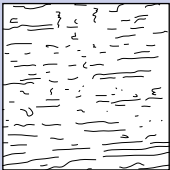

Linear small design (block frame)

					
		Woodgrain	Woodgrain - Standard Colour		
Overall Frame Dimensions Width x Height (mm x mm)					
		Premium	Premium		
855	x	1990	1367 ¹	1628	Profile Type 2 only
855	x	2115	1367 ¹	1628	
980	x	1990	1416 ¹	1676	
980	x	2115	1416 ¹	1676	
990	x	2058	1367 ²	1628	Profile Type 1 & 2
990	x	2183	1367 ²	1628	
1115	x	2058	1416 ²	1676	
1115	x	2183	1416 ²	1676	
855 - 1200		x	1800 - 2100	1693	1954
1201 - 1330		x	2101 - 2558	1737	1997

Profile 1: Only opening inwards

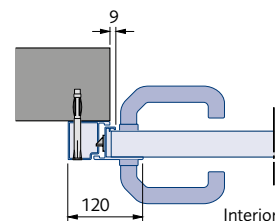

Profile 2: Opening inwards

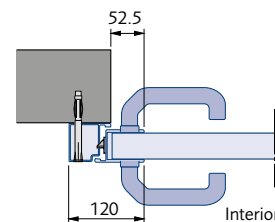

Profile 2: Opening inwards or outwards (inwards shown)

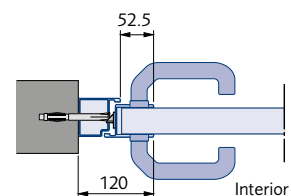





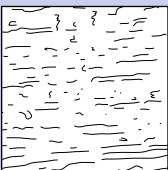
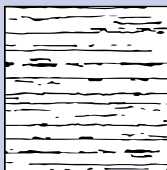
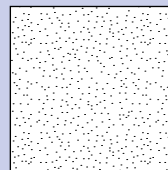

¹ These doors are only suitable for fitting between the opening (opening inwards or outwards).

² These doors are only suitable for fitting behind the opening (opening inwards).

Premium Side Doors

Linear medium design (corner frame)

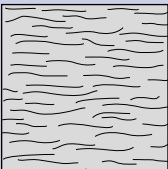
										
		Woodgrain - White			Slategrain - White			Silkgrain - White		
<p>Overall Frame Dimensions Width x Height (mm x mm)</p>										
		Premium			Premium			Premium		
875	x	2000	1367	1367	1481	Profile Type 1 & 2				
875	x	2125	1367	1367	1481					
1000	x	2000	1416	1416	1538					
1000	x	2125	1416	1416	1538					
875 - 1200	x	1800 - 2100	1693	1693	1813					
1201 - 1284	x	2101 - 2500	1737	1737	1856					

										
		Timber Effect / Titan (CH 703)								
<p>Overall Frame Dimensions Width x Height (mm x mm)</p>										
		Premium								
875	x	2000	1645	Profile Type 1 & 2						
875	x	2125	1645							
1000	x	2000	1709							
1000	x	2125	1709							
875 - 1200	x	1800 - 2100	1976							
1201 - 1284	x	2101 - 2500	2017							

Profile 1: Only opening inwards

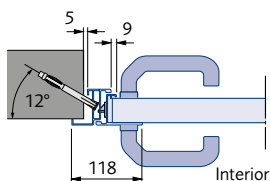

Profile 2: Opening inwards

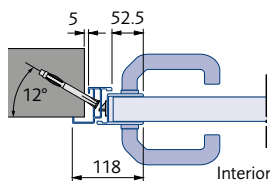

Profile 2: Opening outwards

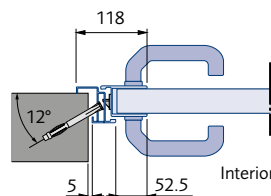

Premium Side Doors

Linear medium design (corner frame)

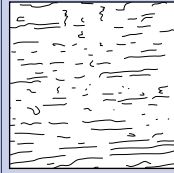
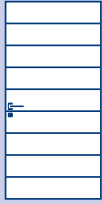

Woodgrain - Standard Colour

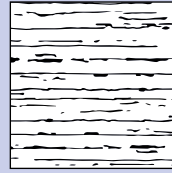

Slategrain - Standard Colour

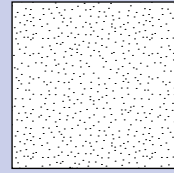

Silkgrain - Standard Colour



Premium



Premium



Premium

Overall Frame Dimensions
Width x Height
(mm x mm)

875	x	2000	1628	1628	1742
875	x	2125	1628	1628	1742
1000	x	2000	1676	1676	1799
1000	x	2125	1676	1676	1799
875 - 1200	x	1800 - 2100	1954	1954	2074
1201 - 1284	x	2101 - 2500	1997	1997	2116

Linear medium design (block frame)

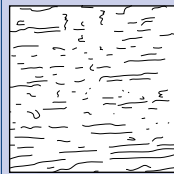
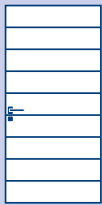

Woodgrain - White

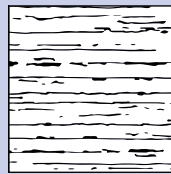

Slategrain - White

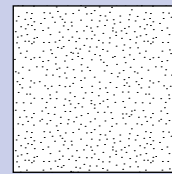

Silkgrain - White



Premium



Premium



Premium



Overall Frame Dimensions
Width x Height
(mm x mm)

855	x	1990	1367 ¹	1367 ¹	1481 ¹	Profile Type 2 only
855	x	2115	1367 ¹	1367 ¹	1481 ¹	
980	x	1990	1416 ¹	1416 ¹	1538 ¹	
980	x	2115	1416 ¹	1416 ¹	1538 ¹	
990	x	2058	1367 ²	1367 ²	1481 ²	Profile Type 1 & 2
990	x	2183	1367 ²	1367 ²	1481 ²	
1115	x	2058	1416 ²	1416 ²	1538 ²	
1115	x	2183	1416 ²	1416 ²	1538 ²	
855 - 1200	x	1800 - 2100	1693 ²	1693 ²	1813 ²	
1201 - 1330	x	2101 - 2558	1737 ²	1737 ²	1856 ²	

¹ These doors are only suitable for fitting between the opening (opening inwards or outwards).

² These doors are only suitable for fitting behind the opening (opening inwards).

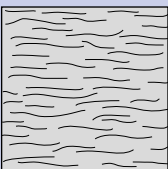
Premium Side Doors

Linear medium design (block frame)				
			Timber Effect / Titan (CH 703)	
Overall Frame Dimensions Width x Height (mm x mm)			Premium	
855	x	1990	1645 ¹	
855	x	2115	1597 ¹	
980	x	1990	1709 ¹	
980	x	2115	1709 ¹	
990	x	2058	1645 ²	
990	x	2183	1645 ²	
1115	x	2058	1709 ²	
1115	x	2183	1709 ²	
855 - 1200		x	1800 - 2100	1976
1201 - 1330		x	2101 - 2558	2017

Profile 1: Only opening inwards

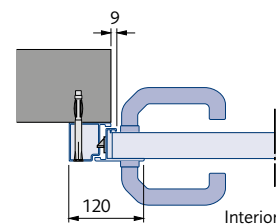



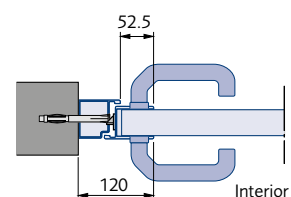

Profile 2: Opening inwards or outwards (inwards shown)

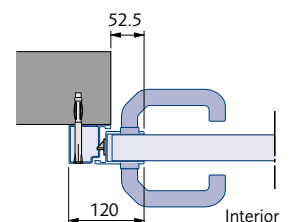

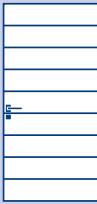
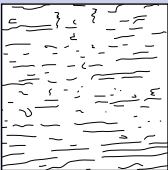
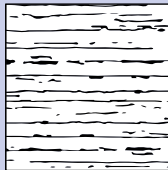
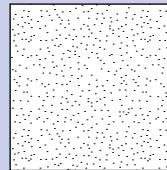
Profile 2: Opening inwards







			Woodgrain - Standard Colour		Slategrain - Standard Colour		Silkgrain - Standard Colour
Overall Frame Dimensions Width x Height (mm x mm)			Premium		Premium		Premium
855	x	1990	1628 ¹	1628 ¹	1742 ¹		
855	x	2115	1628 ¹	1628 ¹	1742 ¹		
980	x	1990	1676 ¹	1676 ¹	1799 ¹		Profile Type 2 only
980	x	2115	1676 ¹	1676 ¹	1799 ¹		
990	x	2058	1628 ²	1628 ²	1742 ²		
990	x	2183	1628 ²	1628 ²	1742 ²		
1115	x	2058	1676 ²	1676 ²	1799 ²		Profile Type 1 & 2
1115	x	2183	1676 ²	1676 ²	1799 ²		
855 - 1200		x	1800 - 2100	1954 ²	1954 ²	2074 ²	
1201 - 1330		x	2101 - 2558	1997 ²	1997 ²	2116 ²	

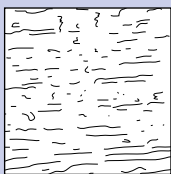
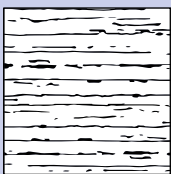
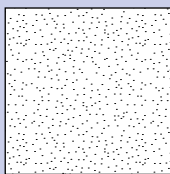

¹ These doors are only suitable for fitting between the opening (opening inwards or outwards).

² These doors are only suitable for fitting behind the opening (opening inwards).

Premium Side Doors

Linear large design (corner frame)

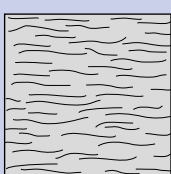
										
		Woodgrain - White			Slategrain - White			Silkgrain - White		
<p>Overall Frame Dimensions Width x Height (mm x mm)</p>										
		Premium			Premium			Premium		
875	x	2000	1538	1538	1538	1661				Profile Type 1 & 2
875	x	2125	1538	1538	1538	1661				
1000	x	2000	1594	1594	1594	1715				
1000	x	2125	1594	1594	1594	1715				
875 - 1200	x	1800 - 2100	1754	1754	1754	1872				
1201 - 1284	x	2101 - 2500	1798	1798	1798	1909				

					
		Timber Effect / Titan (CH 703)			
<p>Overall Frame Dimensions Width x Height (mm x mm)</p>					
		Premium			
875	x	2000	1845		Profile Type 1 & 2
875	x	2125	1845		
1000	x	2000	1909		
1000	x	2125	1909		
875 - 1200	x	1800 - 2100	2056		
1201 - 1284	x	2101 - 2500	2095		

Profile 1: Only opening inwards

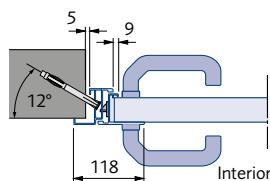

Profile 2: Opening inwards

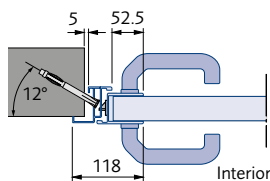



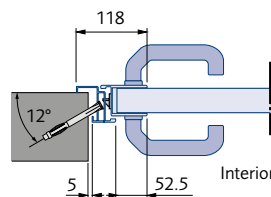

Profile 2: Opening outwards



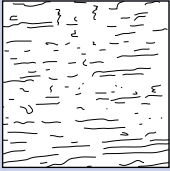
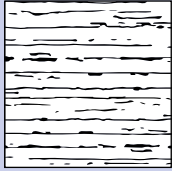
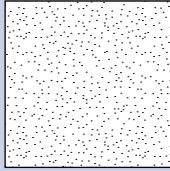



Premium Side Doors

Linear large design (corner frame)

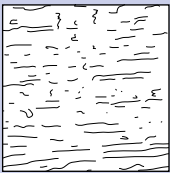
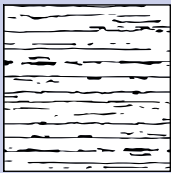
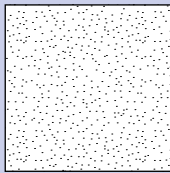
								
			Woodgrain - Standard Colour	Slategrain - Standard Colour	Silkgrain - Standard Colour			
Overall Frame Dimensions Width x Height (mm x mm)								
875	x	2000	1799	1799	1921			Profile Type 1 & 2
875	x	2125	1799	1799	1921			
1000	x	2000	1855	1855	1975			
1000	x	2125	1855	1855	1975			
875 - 1200	x	1800 - 2100	2015	2015	2132			
1201 - 1284	x	2101 - 2500	2058	2058	2169			

Linear large design (block frame)



								
			Woodgrain - White	Slategrain - White	Silkgrain - White			
Overall Frame Dimensions Width x Height (mm x mm)								
855	x	1990	1538 ¹	1538 ¹	1661 ¹			Profile Type 2 only
855	x	2115	1538 ¹	1538 ¹	1661 ¹			
980	x	1990	1594 ¹	1594 ¹	1715 ¹			
980	x	2115	1594 ¹	1594 ¹	1715 ¹			
990	x	2058	1538 ²	1538 ²	1661 ²			Profile Type 1 & 2
990	x	2183	1538 ²	1538 ²	1661 ²			
1115	x	2058	1594 ²	1594 ²	1715 ²			
1115	x	2183	1594 ²	1594 ²	1715 ²			
855 - 1200	x	1800 - 2100	1754	1754	1872			
1201 - 1330	x	2101 - 2558	1798	1798	1909			

¹ These doors are only suitable for fitting between the opening (opening inwards or outwards).

² These doors are only suitable for fitting behind the opening (opening inwards).

Premium Side Doors

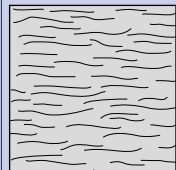
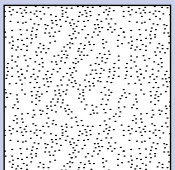
Linear large design (block frame)

						
						
Overall Frame Dimensions Width x Height (mm x mm)						
855	x	1990	1845 ¹	1845 ¹	Profile Type 2 only	
855	x	2115	1845 ¹	1845 ¹		
980	x	1990	1909 ¹	1909 ¹		
980	x	2115	1909 ¹	1909 ¹		
990	x	2058	1845 ²	1845 ²	Profile Type 1 & 2	
990	x	2183	1845 ²	1845 ²		
1115	x	2058	1909 ²	1909 ²		
1115	x	2183	1909 ²	1909 ²		
855 - 1200	x	1800 - 2100	1754	1754		
1201 - 1330	x	2101 - 2558	1798	1798		

Profile 1: Only opening inwards

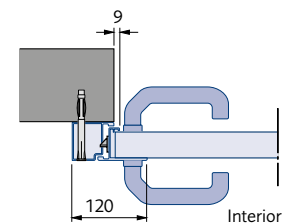



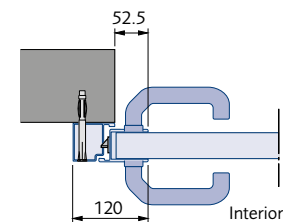

Profile 2: Opening inwards

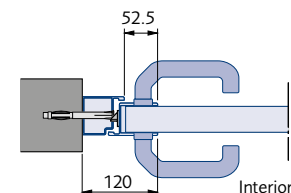

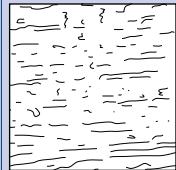
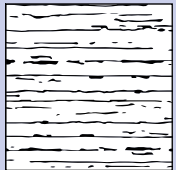
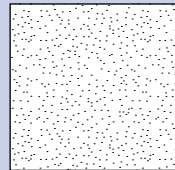
Profile 2: Opening inwards or outwards (inwards shown)



							
							
Overall Frame Dimensions Width x Height (mm x mm)							
855	x	1990	1799 ¹	1799 ¹	1921 ¹	Profile Type 2 only	
855	x	2115	1799 ¹	1799 ¹	1921 ¹		
980	x	1990	1855 ¹	1855 ¹	1975 ¹		
980	x	2115	1855 ¹	1855 ¹	1975 ¹		
990	x	2058	1799 ²	1799 ²	1921 ²	Profile Type 1 & 2	
990	x	2183	1799 ²	1799 ²	1921 ²		
1115	x	2058	1855 ²	1855 ²	1975 ²		
1115	x	2183	1855 ²	1855 ²	1975 ²		
855 - 1200	x	1800 - 2100	2015	2015	2132		
1201 - 1330	x	2101 - 2558	2058	2058	2169		

¹ These doors are only suitable for fitting between the opening (opening inwards or outwards).

² These doors are only suitable for fitting behind the opening (opening inwards).

Premium Side Doors

Window options

Linear small design



Prices £ stated per window Window frames white as standard	Linear 1
Premium - Woodgrain ¹	154

Linear medium design

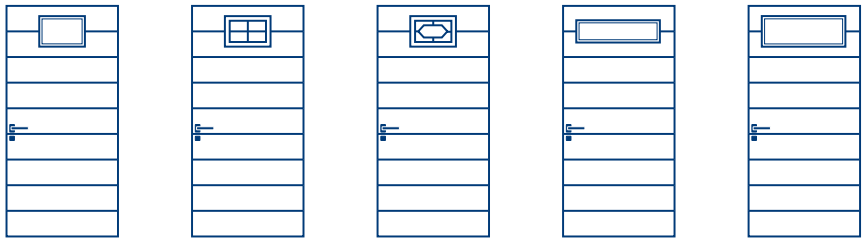

Prices £ stated per window Window frames white as standard	Standard	Cross	Diamond	Linear 1	Linear 2
Premium - Woodgrain, Duragrain, Silkgrain ¹	154	190	190	154	187
Premium-Timber Effect ²	195	231	231	195	228

Linear large design

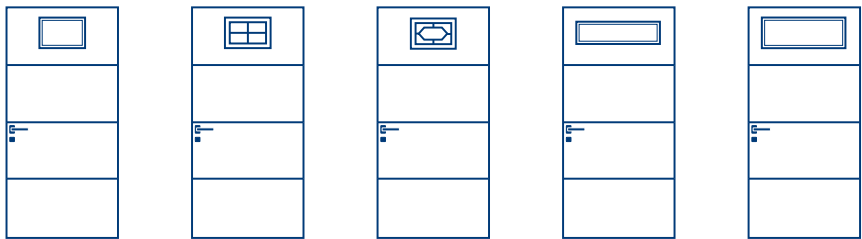

Prices £ stated per window Window frames white as standard	Standard	Cross	Diamond	Linear 1	Linear 2
Premium - Woodgrain, Duragrain, Silkgrain ¹	154	190	190	154	187
Premium-Timber Effect ²	195	231	231	195	228

¹ Colours available at surcharge (£44 for standard colour, £73 for non-standard colour, £135 for special RAL colour).

² Windows are painted in a colour to best match the foil coat (colour included in the price).

Standard window options only available with clear synthetic double pane glazing or crystal synthetic double pane glazing.
Standard = S0, Cross = S1, Diamond = S2, Linear 1 = Type D, Linear 2 = Type M0, Linear 3 = Type L0.

Depending on the width of the door specified, the appearance of windows may vary. Doors are manufactured with one window door leaf.

Please state on order if clear or crystal panes.

Side Hinged Garage Doors

Colour Options for Premium range

Premium Side Hinge Surcharge for RAL to choose	762
Side Door Surcharge for RAL to choose	253

Options for premium side doors

Overhead door closer with slide rail and hold open device (single leaf side door)	383
3-point locking with latch, bolt, 2 locking hooks and 3 security bolts on the hinge side and with security rose escutcheon (single leaf side door). Profile type 2 only, cannot be retro-fitted	586
Profile double cylinder (35 + 30 mm). Keys to pass, for side doors profile type 1	124
Profile double cylinder (35 + 35 mm). Keys to pass, for side doors profile type 2	132
Door stay (with 60 mm lifting)	172
Door stay (with 120 mm lifting)	356

Handles (all handles are prepared for profile cylinder)

Lever / lever cast aluminium – natural finish	166
Lever / lever cast aluminium – black paint	203
Lever / lever – white (RAL 9016)	203
Lever / lever brushed stainless steel	220
Lever / knob – black plastic	91
Lever / knob cast aluminium ñ natural finish	194
Lever / knob cast aluminium ñ white (RAL 9016)	241
Lever / knob cast aluminium ñ black paint	241
Lever / knob -brushed stainless steel	256

Options for premium side hinged doors only

Overhead door closer with slide rail and hold open device. Fitting on traffic leaf (double leaf)	383
Overhead door closer with slide rail and hold open device. Fitting on traffic leaf and fixed lead (double leaf)	383
3-point locking with latch, bolt, 2 locking hooks and 3 security bolts on the hinge side and with security rose escutcheon (double leaf)	735
Door stay (with 60 mm lifting). Please note, for side-hinged doors two door stays are required	345
Door stay (with 120 mm lifting). Please note, for side-hinged doors two door stays are required	712

Automation and Accessories

Operators

GaraMatic operators are an ideal match for all current Garador up & over and sectional garage doors. They are a tried and tested hardware combination, designed for use with Garador up & over or sectional garage doors, and prepared for easy installation. They feature energy efficient LED light, a power saving mode and a mechanical lock, built into the operator boom, to prevent forced lifting of the door.

What's included

All GaraMatic operators come as a complete set, including operator head, boom and two 4-button hand transmitters.



BlueSecur App

The Garador BlueSecur app allows you to control your Series 4 GaraMatic operator from your android or ios smartphone. It allows you to operate the open/close, partial opening and integral light functions. Both the GaraMatic 10 and GaraMatic 20 are supplied complete with an integrated bluetooth receiver, for control via Garador's BlueSecur smartphone app for android and ios devices. One free user key is included. Others available via in-app purchase. Please refer to Garador BlueSecur for pricing. The bluetooth receiver can be switched on and off. An optional bluetooth receiver is available as an add-on for the GaraMatic 9.



BS EN 13241 Compliant

The combination of Garador garage doors with GaraMatic operators complies with the latest European safety standards.

Automation and Accessories

Operators

GaraMatic 9



Peak forces
750 N

- Simple to operate
- Soft start and stop
- Max. opening speed 20 cm/s
- Automatic safety reversal
- Integral LED light with 10 LEDs
- Low power consumption (less than 1 w in stand by mode)
- Supplied with two 4-button hand transmitters (black end caps)

GaraMatic 10



Peak forces
800 N

- Control element with 2x 7-segment display
- Soft start and stop
- Max. opening speed 25 cm/s
- Automatic safety reversal
- Adjustable integral LED light with 20 LEDs
- Partial opening function
- Self-closing timer option
- Integrated bluetooth receiver
- HCP interface to connect smarhome systems
- Low power consumption (less than 1 w in stand by mode)
- Supplied with two 4-button hand transmitters (chrome end caps)
- BlueSecur App: One free user key included. Others available via in-app purchase

GaraMatic 20



Peak forces
1000 N

- Control element with 2x 7-segment display
- Soft start and stop
- Max. opening speed 25 cm/s
- Automatic safety reversal
- Adjustable integral LED light with 30 LEDs
- Partial opening function
- Self-closing timer option
- Integrated bluetooth receiver
- HCP interface to connect smarhome systems
- Low power consumption (less than 1 w in stand by mode)
- Supplied with two 4-button hand transmitters (chrome end caps)
- BlueSecur App: One free user key included. Others available via in-app purchase

Canopy Doors ¹	685	862	919
Standard short boom ² Retractable and Sectional Doors up to 2125 mm high	561	692	769
Medium boom ²	598	730	807
Long boom ²	718	849	926

¹ Canopy door price includes bow arm system. GaraMatic 9 supplied with two 2-channel hand transmitters.

² For exact boom requirements see grid on page 97.

Automation and Accessories

Accessories



Article	Hand transmitter 5-channel (Bi-directional) in matt black	Hand transmitter 4-channel (Bi-directional) in matt black	Hand transmitter 4-channel (Bi-directional) in matt black (chrome caps)	Hand transmitter 5-channel (Bi-directional) in white
Reference No.	7471	7470	6809	6713
Price £	98	82	82	98



Article	Hand transmitter 5-channel (Bi-directional) in black	Hand transmitter 1-channel (Bi-directional) in black	Hand transmitter 4-channel (Bi-directional) in black	Hand transmitter station in black
Reference No.	6714	6710	6779	6719
Price £	98	82	82	16



Article	Hand transmitter station in white	Hand transmitter sun visor/wall holder	1-channel (Bi-directional) transmitter for car cigarette lighter	2-channel (Bi-directional) transmitter for car cigarette lighter
Reference No.	6720	6784	6782	6783
Price £	16	14	75	75

Automation and Accessories

Accessories



Article	Hand transmitter 2-channel (Bi-directional) Green	Robust 3-channel (Bi-directional) hand transmitter	IT3 B Wired Wall Console	FIT 2 Bi-directional wireless wall console
Reference No.	6965	8880	8733	6718
Price £	82	115	57	111



Article	IT1 B Wired illuminated push button	Series 4 External Bluetooth Antenna to increase signal range	IT1-1 Internal Push Button	FCT 3 BS Radio code switch
Reference No.	2875	8128	9064	6717
Price £	47	111	35	146

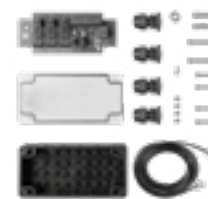

Article	FCT 10 Wireless Code Switch (flip lid) 868 mHz bi-directional	Series 4 External Bluetooth receiver (GaraMatic 9 add-on)	Options relay for control of garage light, warning light or limit switch report HOR-HCP	Series 4 Universal Adapter Print for control of operator light, partial open and ventilation position UAP-1-HCP
Reference No.	6716	8129	8125	8421
Price £	219	177	73	143

Automation and Accessories

Accessories



Article	EL301N External light beam device	Emergency Battery Backup HNA 18-4 (for Series 4 operators)	EL201 Internal light beam device
Reference No.	2994	8435	9156
Price £	176	289	107

Additional options

De-latching kit Reference No. 705 for up & over doors, Garador single door range (437.195) (required to maintain mechanical locking system retractable doors only)	74
De-latching kit Reference No. 2643 for up & over doors, Garador double door range (437.197) (required to maintain mechanical locking system retractable doors only)	120
Emergency release Reference No. 704 for retractable up & over doors only (required if door is electrically operated and has no other personal access)	49
Emergency release Reference No. 703 for sectional door without handle and lock, or canopy up & over doors (required if door is electrically operated and has no other personal access)	67
Emergency release Reference No. 702 for sectional door with handle and lock (required if door is electrically operated and has no other personal access)	69
Lintel extension bracket Reference No. 709 for canopy doors (required if door is fitted between brickwork under the lintel)	67

Automation and Accessories

Operator Specifications

Boom for canopy door including canopy bow arm

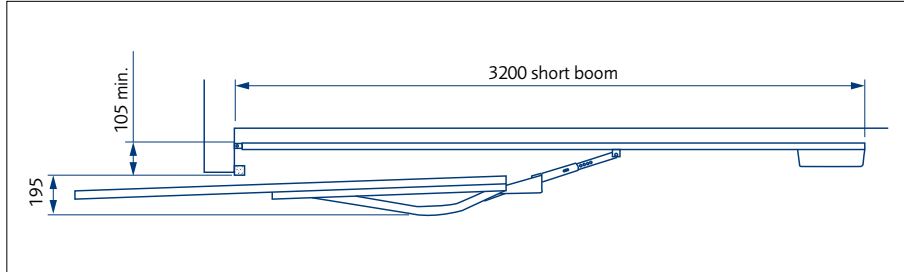

On horizontal doors the bow arm is to be fitted off centre.

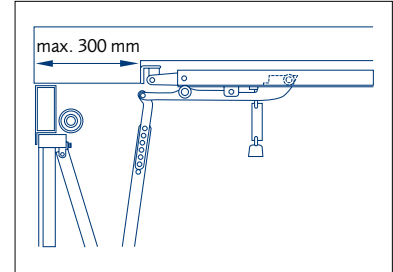

Lintel extension bracket required for canopy doors fitted between the brickwork and under the lintel head.

Boom for retractable door

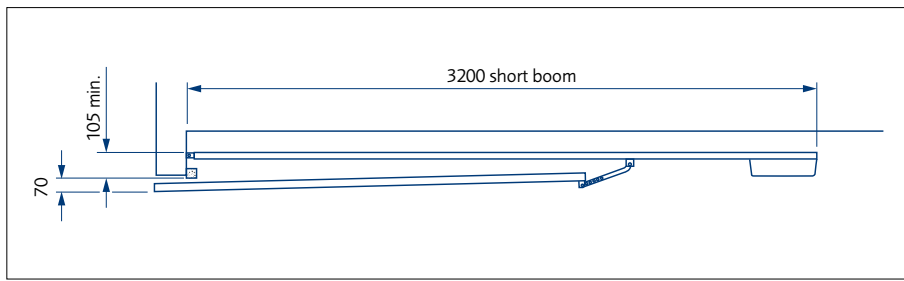

Boom for sectional door

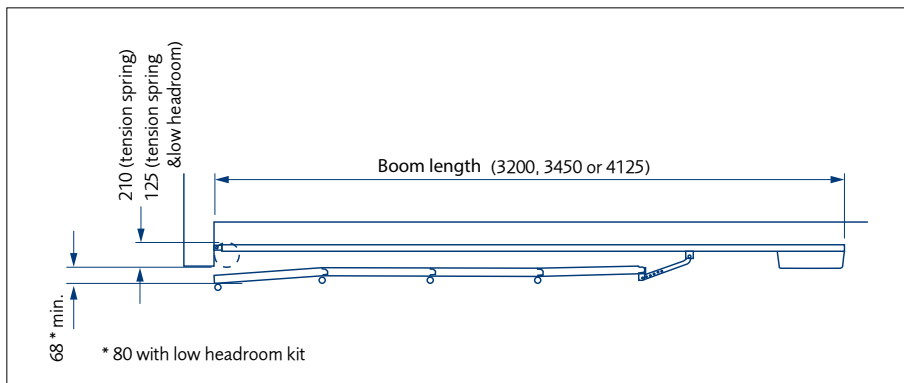

Maximum Door Height to suit Operator Booms			
	Torsion Spring	Tension and Low Headroom Spring	Travel distance
Short Boom	2250 mm	2125 mm	2475 mm
Medium Boom	2500 mm	2375 mm	2725 mm
Long Boom	3000 mm	3000 mm	3400 mm

GaraRoll Roller Doors

GaraRoll Insulated Roller Doors

Spring-compensated, automated roller garage door for domestic applications only. All doors are made to suit the opening with the actual door size relating to the structural opening width x height and the guides fitting on the reveals to maintain a full opening size. The GaraRoll is the only roller garage door to include the cover hood, which the curtain rolls into at the head of the garage door opening, as standard. The door is also supplied complete with a DuraBelt anti-scratch system, designed to provide a protective layer between each lath as they roll up when the door is open.

Door curtain

77 mm rolled aluminium profile filled with 100 % CFC-free polyurethane rigid foam. Each lath is 15mm thick. Integrated windlocks fitted as standard.

Surface

Colour finish with double layer coil coating quality paint system or foil-coated timber effect finish.

Frame

Aluminium extrusion profile side guides with integrated plastic runners. Lintel and cover box made of steel. Colour of side guides and lintels supplied to match the door as standard. Except on foil-coated and deco paint timber effect doors where they are supplied in a solid brown paint finish. Cover box coated Grey White (RAL 9002).

Counterbalance

Tension spring technology with lateral integral double tension springs and double cables encased within a transparent cover.

Colours

Same colour inside and outside

- Light Ivory (RAL 1015)
- Ruby Red (RAL 3003)
- Purple Red (RAL 3004)
- Steel Blue (RAL 5011)
- Moss Green (RAL 6005)
- Slate Grey (RAL 7015)
- Anthracite Grey (RAL 7016)
- Light Grey (RAL 7035)
- Agate Grey (RAL 7038)
- Terra Brown (RAL 8028)
- Cream (RAL 9001)
- Jet Black (RAL 9005)
- White Aluminium (RAL 9006)
- Grey Aluminium (RAL 9007)
- Traffic White (RAL 9016)
- Chartwell Green

Deco paint doors available in Anthracite Metallic (Noir 2100 Sable), Golden Oak and Rosewood, with the same finish inside and out.

Foil-coated doors available in Golden Oak and Rosewood, with the inside of the lath in dark brown (foil coat not available on GaraRoll external roller garage door).

GaraRoll Roller Doors

Operator and Control

Garador operator and control included. 24 V DC gear drive, mains voltage 230-240 V AC, 0.5 kW, opening speed approx. 11 cm/s, integrated door security kit, operator always located on left (viewed from inside), plastic housing. Micro-processor control in separate plastic housing, automatic teaching of auto safety cut-out and travel limits, soft start and soft stop, light, impulse control, adjustable automatic timer (hold-open time 30 sec. after activation, additional photocell required). Included: 2 hand transmitters and integral receiver, connecting lead with CEE plug, control buttons in cover of the control unit, integrated 2-minute garage light in control housing, quick release (operated from inside). Please note, a wired optical sensor is included as a mandatory safety feature for all GaraRoll doors over 5000 mm wide.

Windows

Window size approx. 120 x 40 mm, number of windows per door section depends on door width. Windows made of clear synthetic pane with black window frame on exterior, transparent frame on interior. Maximum of 10 window sections per door. Window arrangement:

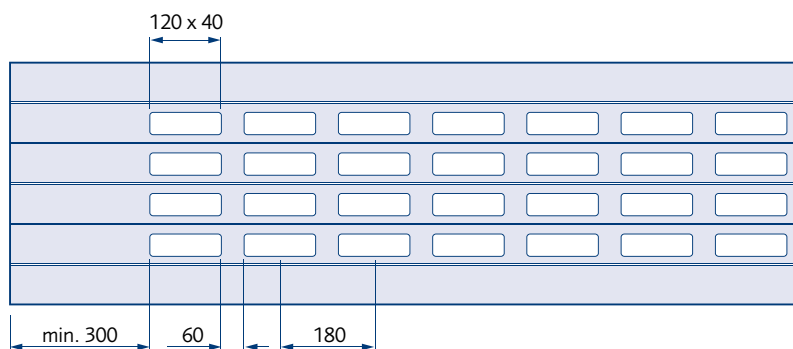

GaraRoll SBD

Only possible when installed completely behind opening. For clarification – no fascia or guides can show into the opening

- Only available in width range 1900mm – 3000mm
- Only available in heights range 2000mm – 3100mm
- Not available with windows or ventilation grills
- Not available with emergency release

Packaging

GaraRoll doors are supplied in a palletted format shrink wrapped as a complete package.

GaraRoll Roller Doors

Stock availability

All GaraRoll doors are made to order with no standard sizes. Lead-time for all doors is 3 to 4 weeks.

Remember the GaraRoll door is measured as opening size and not as overall guide width.

This not only makes it the same as all other Garador doors for sizing but also will probably reduce the price against other doors as most other door manufacturers calculate the price as over guide width thus making the actual door around 220 mm smaller!



Secured by Design is an association focusing on the design of more secure homes and commercial properties. Secured by Design is owned by the ACPO (Association of Chief Police Officers) and awards the Secured by Design status to products that pass their extensive testing procedures.

GaraRoll Roller Doors

Minimum product dimension is 1000 mm x 1600 mm.

Only the door prices highlighted are available with the external roller garage door fitting as an option.

Smooth paint finish

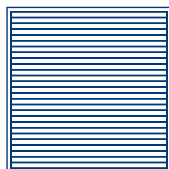

Door height	Door width																					
	1000	1250	1500	1750	1900	2000	2250	2500	2750	3000	3250	3500	3750	4000	4250	4500	4750	5000	5250	5500	5750	6000
1600																						
1800	2853	2853	2771	2771	2798	2947	3045	3147	3189	3441	3543	3963	4054	4231	4324	4425	4523	4851	4950	5050	5148	
2000	2853	2853	2771	2771	2798	2947	3045	3147	3189	3441	3543	3963	4054	4231	4324	4425	4523	4851	4950	5050	5148	
2125	2853	2853	2771	2771	2897	3076	3123	3205	3294	3556	3668	4124	4162	4407	4505	4606	4702	5029	5127	5226	5324	
2250	2853	2853	2771	2771	2945	3166	3238	3306	3427	3731	4103	4258	4295	4529	4622	4722	4817	5144	5239	5332	5428	
2375	2853	2853	2771	2771	2945	3166	3238	3306	3427	3731	4103	4258	4295	4529	4622	4722	4817	5144	5239	5332	5428	
2500	2853	2853	3004	3004	3044	3218	3320	3440	3534	3852	4255	4334	4500	4678	4778	4873	4969	5296	5388	5485	5580	
2625	2853	2853	3004	3004	3142	3308	3412	3538	3665	4239	4412	4563	4715	4830	4931	5024	5119	-	-	-	-	
2675	2853	2853	3004	3004	3142	3308	3412	3538	3665	4239	4412	4563	4715	4830	4931	5024	5119	-	-	-	-	
2750	-	-	-	-	-	3308	3412	3538	3665	4239	4412	4563	4715	-	-	-	-	-	-	-	-	
2875	-	-	-	-	-	3447	3534	3642	3731	4361	4508	4689	4781	-	-	-	-	-	-	-	-	
3000	-	-	-	-	-	3447	3534	3642	3731	4361	4508	4689	4781	-	-	-	-	-	-	-	-	
3100	-	-	-	-	-	3447	3534	3642	3731	4361	4508	4689	4781	-	-	-	-	-	-	-	-	

Options for GaraRoll doors

		add
Timber effect finish	per m ²	75
Deco paint finish	per m ²	40
Surcharge for different colour frame and guides to door colour		177
Manually operated version (not possible on external fit)	Price reduction	271
Removal of barrel casing (optional only on door height 2500 mm and over)	Price reduction per m ²	28
External fit (reverse rolled)		124
Chamfered bottom profile available only in White or Colour. Not available in timber effect finish	per m ²	509
Ventilation grilles or Glazing element with clear synthetic pane, window section 120 x 40 mm, black glazing frame on exterior, transparent on interior (maximum of 10 sections per door, number of glazing elements dependent on the door width) ¹	per m ²	47

¹ Not available in top 8 laths.

GaraRoll Roller Doors

Accessories for GaraRoll operator		add
Bi-directional hand transmitter, 5-channel in black		100
Bi-directional hand transmitter mini, 4-channel in black		85
Motor connection line, 10 m - Reference No. 8669		44
Acoustic door security kit - Reference No. 8671		97
Emergency battery HNA 18 - Reference No. 8126		302
Exterior emergency release - Reference No. 5501		290
Exterior emergency release has two choices:	External fit	173
Additional fascia panel required when fitting a door within the opening, ordering size will need to be door size plus guide width (price per metre) supplied in colour to match the door / guides		83

All other operator accessories can be combined with GaraRoll roller doors. Please see page 122.
 GaraRoll is also available with a colour door curtain and white guide rails and box cover, at an additional cost of £172. If required, please state clearly on your order.
 Bluetooth as standard with GaraRoll.

Operator Specifications

Fitting behind the opening

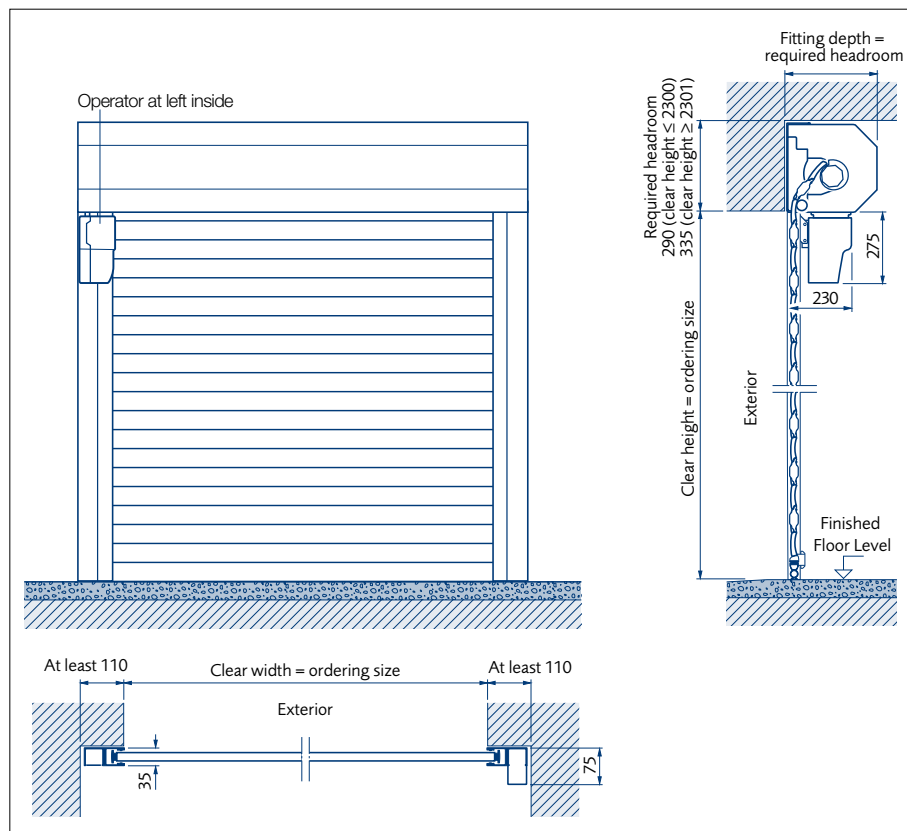

GaraRoll Roller Doors

Fitting in the opening

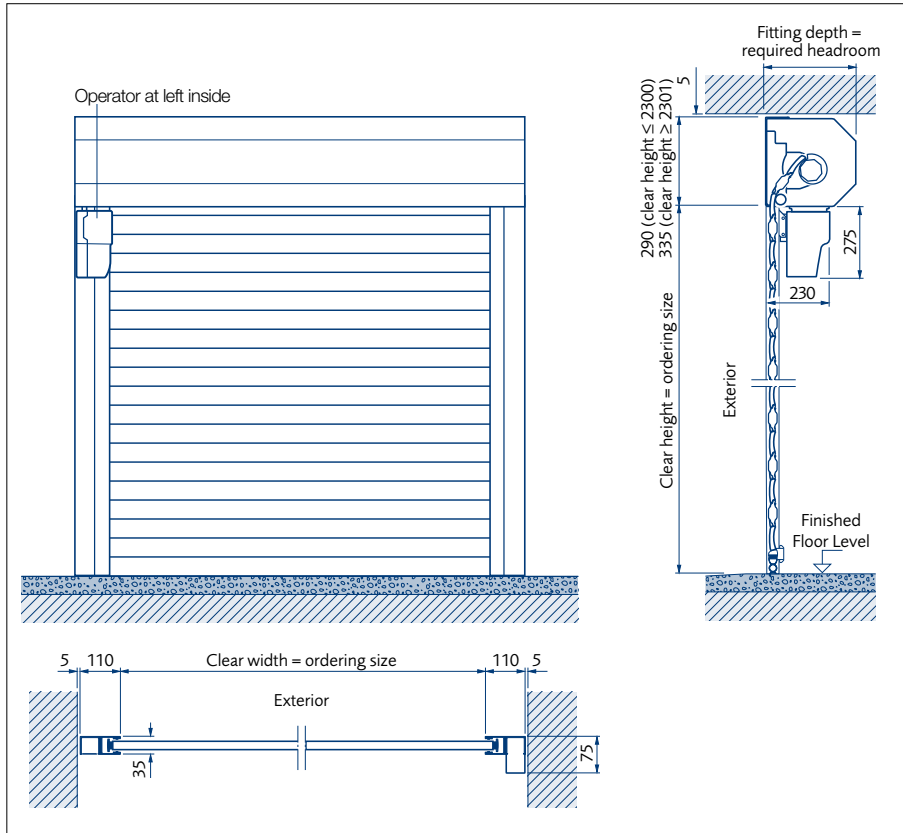

Clear passage width =
clear width (ordering size)

Clear passage height =
clear height (ordering size)

- 80 mm for automated version,
- 140 mm for manually operated version

GaraGlide Roller Doors

GaraGlide Roller Doors

A motor driven, roller garage door with tubular drive motor, closing edge safety device and manual hand crank for emergencies. The emergency release kit is not available for a retro-fit application so must be ordered with the original door. All doors are built to suit the opening, with the actual door size relating to the structural opening width x height and the guides fitting on the reveals to maintain a full opening size. Please refer to sizing tables for full range of size options.

Door Curtain

77 mm rolled aluminium profile with 100 % CFC-free polyurethane rigid foam. Available in 16 standard colour, with a two-layer paint finish using a high-quality polyurethane paint coated with a polyimide. Each lath is 15 mm thick.

Frame and Construction

75 mm guide rails for single doors and 105 mm for double doors. Guide rails are supplied in a colour to match the door curtain and with an integrated brush strip either side. The box cover, rollers and barrel are pre-assembled for convenience. Please state on your order if fitting between or behind opening.

Operator and Control

GaraGlide operator and control included. 24 V DC gear drive, mains voltage 230 - 240 V AC, 0.5 KW, anti-lift kit, operator built into tubular drive with control board located on right as standard (viewed from inside) and impulse control. Operator with mechanically adjustable end-of-travel position. Included: 2 x bisecur 868 MHz hand transmitters and integral receiver, connecting lead with CEE plug, control buttons in cover of the control unit, integrated 2-minute garage courtesy light in control housing. The motor can be fitted either side. Also features an adjustable reversing procedure, adjustable pre-warning phase, adjustable automatic timer, connection of external illumination is possible and there is also a connecting option for a one-way photo cell.

Standard Colours

GaraGlide roller doors are available in a choice of 15 standard colours, with the door curtain interior and exterior painted the same colour:

- Traffic White (RAL 9016)
- Light Ivory (RAL 1015)
- Ruby Red (RAL 3003)
- Purple Red (RAL 3004)
- Steel Blue (RAL 5011)
- Moss Green (RAL 6005)
- Slate Grey (RAL 7015)
- Anthracite Grey (RAL 7016)
- Light Grey (RAL 7035)
- Agate Grey (RAL 7038)
- Terra Brown (RAL 8028)
- Cream (RAL 9001)
- Jet Black (RAL 9005)
- White Aluminium (RAL 9006)
- Grey Aluminium (RAL 9007)
- Chartwell Green

Anthracite Metallic (Noir 2100 Sable) is also available at an additional cost. See page 105 for additional colour options.

GaraGlide Roller Doors

Timber Effect Colours

A timber effect version is available in Golden Oak or Rosewood effect, where the exterior door curtain is coated in a UV-resistant synthetic foil with a timber effect design and embossed grain, and the interior of the door curtain is painted in Terra Brown (RAL 8028). A Deco Paint version is also available at a lower cost, where the laths are painted in a Golden Oak or Rosewood effect.

Fitting

The GaraGlide is suitable for fitting between and behind a prepared brickwork opening.

GaraGlide SBD

Only possible when installed completely behind opening. For clarification – no fascia or guides can show into the opening

- Only available in width range 1600mm – 2500mm
- Only available in heights range 2000mm – 3100mm
- Not available with electronic limits
- Not available with windows or ventilation grills
- Not available with emergency release

Packaging

GaraGlide roller doors are supplied in two twin-walled cardboard boxes for ease of transportation to site.

Stock Availability

All GaraGlide doors are made to order with no standard sizes. Lead-time for all doors is 4 weeks.

Size range

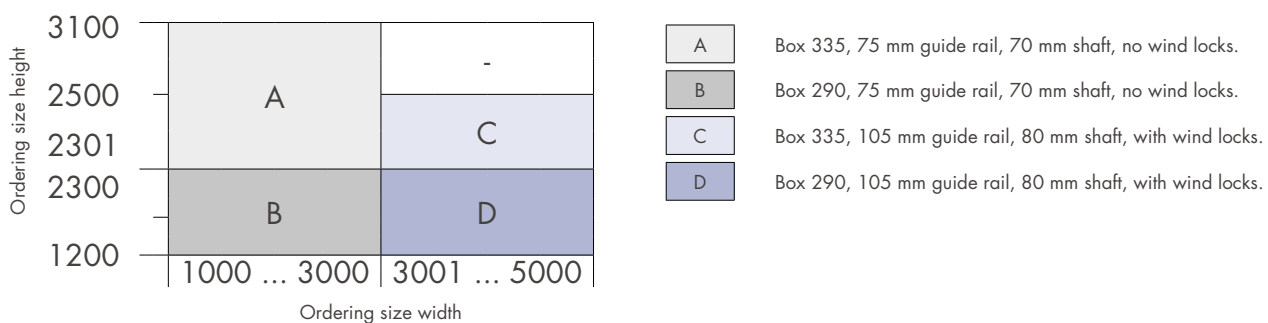

Secured by Design is an association focusing on the design of more secure homes and commercial properties. Secured by Design is owned by the ACPO (Association of Chief Police Officers) and awards the Secured by Design status to products that pass their extensive testing procedures.

GaraGlide Roller Doors

Smooth paint finish

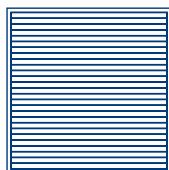

Door height	Door width																	
	1000	1250	1500	1750	1900	2000	2250	2500	2750	3000	3250	3500	3750	4000	4250	4500	4750	5000
1200	2314	2370	2398	2453	2453	2507	2559	2612	2687	3088	3142	3197	3245	3299	3368	3419	3476	
1500	2352	2409	2449	2509	2509	2570	2630	2692	2770	3181	3242	3299	3357	3419	3492	3550	3611	
1750	2381	2446	2494	2559	2559	2622	2683	2746	2836	3255	3317	3383	3447	3511	3593	3652	3717	
2000	2393	2456	2507	2570	2570	2634	2703	2767	2851	3277	3343	3407	3476	3539	3621	3683	3753	
2125	2409	2482	2531	2599	2599	2667	2740	2807	2895	3325	3394	3463	3533	3599	3683	3753	3820	
2250	2441	2514	2570	2641	2641	2721	2792	2867	2959	3394	3465	3539	3611	3793	3881	3953	4031	
2375	2453	2526	2586	2659	2659	2730	2812	2886	2981	3419	3495	3569	3646	3826	3917	3994	4065	
2500	2494	2575	2638	2721	2721	2803	2886	2963	3068	3514	3596	3677	3758	3853	3925	4024	-	
2625	2494	2575	2638	2721	2721	2803	2886	2963	3068	3514	3596	3677	3758	3853	3925	-	-	
2675	2494	2575	2638	2721	2721	2803	2886	2963	3068	3514	3596	3677	3758	3853	3925	-	-	
2750	2531	2622	2692	2776	2776	2867	2951	3041	3154	3717	3800	3889	3979	4082	-	-	-	
2875	2531	2622	2692	2776	2776	2867	2951	3041	3154	3717	3800	3889	3979	-	-	-	-	
3000	2531	2622	2692	2776	2776	2867	2951	3041	3154	3717	3800	3889	3979	-	-	-	-	
3100	2531	2622	2692	2776	2776	2867	2951	3041	3154	3717	3800	3889	3979	-	-	-	-	

Colour Options for GaraGlide Doors

Standard colours (choice of 15 colour options)	Included	
Anthracite Metallic (Noir 2100 Sable)	per m ²	43
Deco Paint (painted timber effect design in Golden Oak or Rosewood)	per m ²	43
Timber effect (plastic film coating in Golden Oak or Rosewood timber effect)	per m ²	77

Add £76 surcharge for external fit GaraGlide roller door.

Add £182 surcharge, to request the door curtain in one colour and the guide rails/box cover in an alternative colour. Please note there is no additional charge for a white frame.

Example of paint cost calculation:

For door dimensions of 2000 mm x 2125 mm, the door area is 4.25 m² (i.e. 2 x 2.125 = 4.25).

Multiply door area by cost per m² to calculate additional paint cost (i.e. 4.25 x 43 = £174.25).

Please note, dark colours should not be used for doors that are exposed to the sun. Despite the use of state-of-the-art colour coating systems, we cannot rule out colour deviations, specifically in metallic colours (RAL 9006 and RAL 9007).

Please state on your order if fitting between or behind opening.

External fit GaraGlide roller doors are only available up to 5000 mm wide and are not available in a timber effect finish.

GaraGlide is also available with a colour door curtain and white guide rails and box cover, at no extra charge. If required, please state clearly on your order.

Roller door fitting dimensions

Fitting behind opening

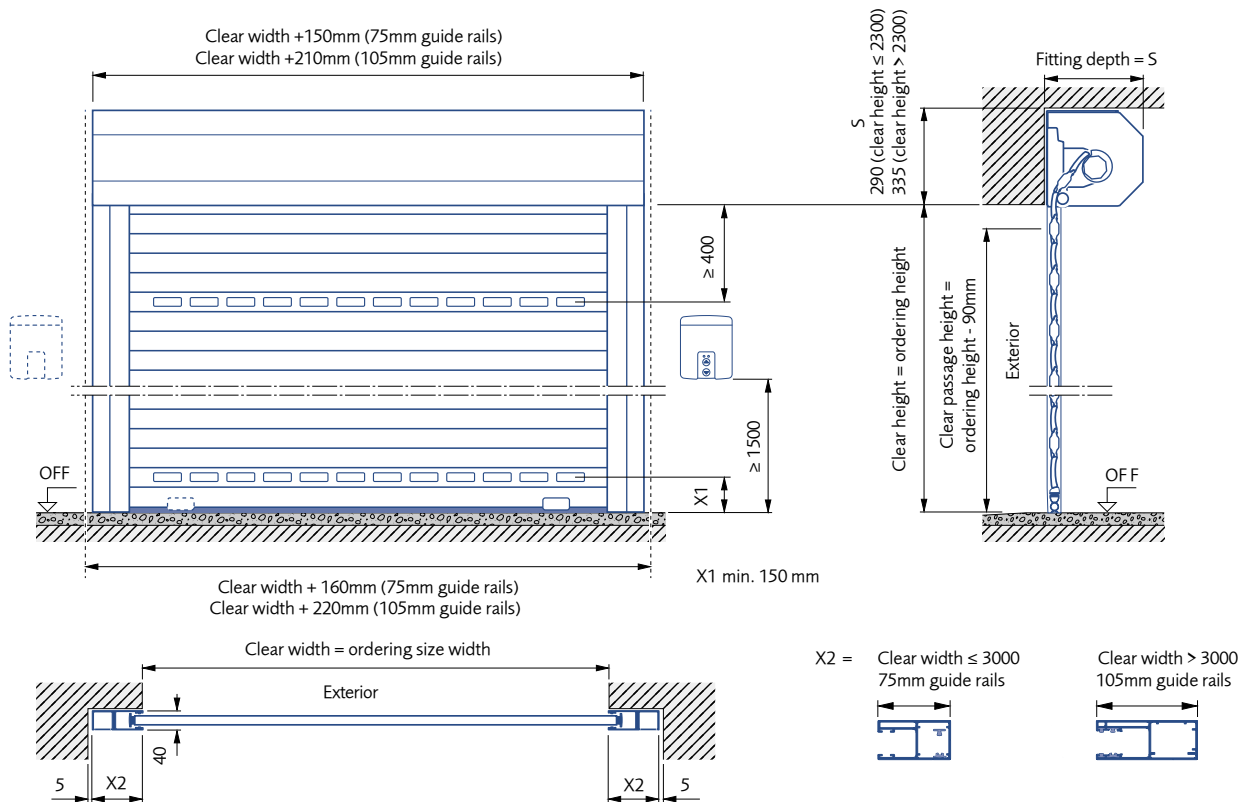

Fitting between opening

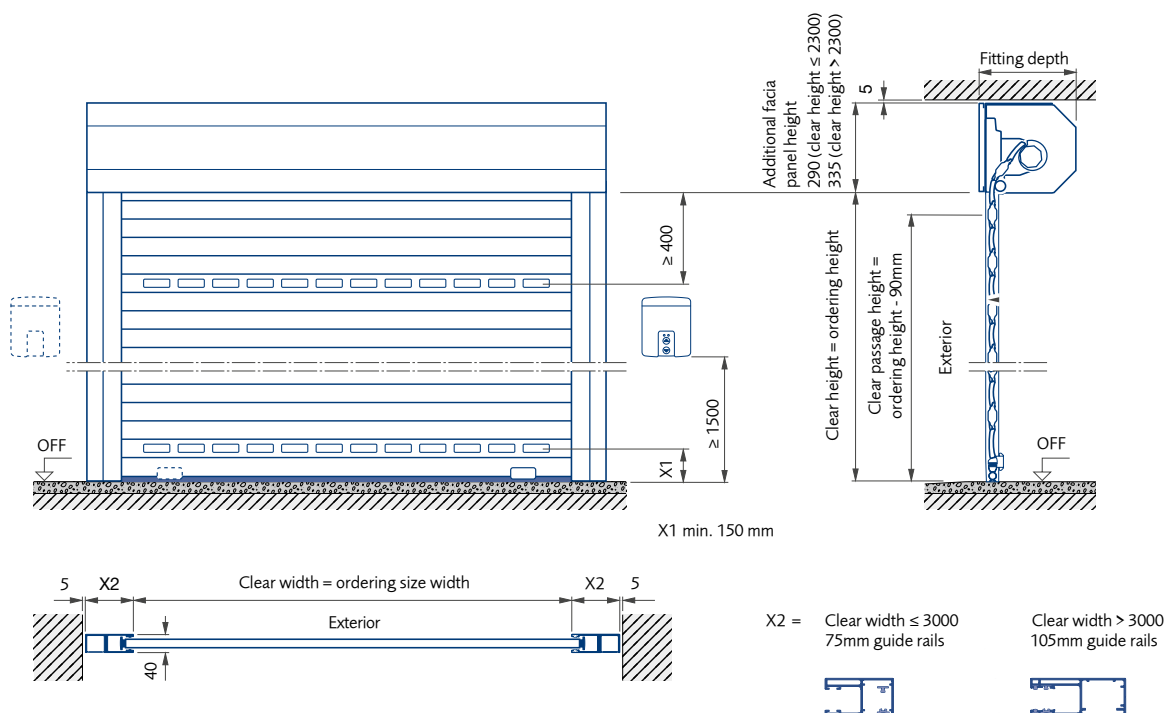

GaraGlide Roller Doors

Options for all GaraGlide roller garage doors

Emergency Release			
	Exterior emergency release kit (Please note: the emergency release kit is not available for a retro-fit application so must be ordered with the original door).	each	300

Not available in Secured By Design Doors

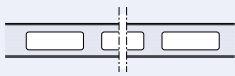
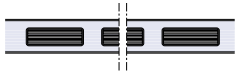
Ventilation Grilles and Glazing Elements			
	Glazing element (clear synthetic pane, window cut-out 112 mm x 33 mm)	per m ²	47
	Ventilation grilles (black plastic with ventilation cross section approx 13 cm ² / grille)	per m ²	47

Not available in Secured By Design Doors

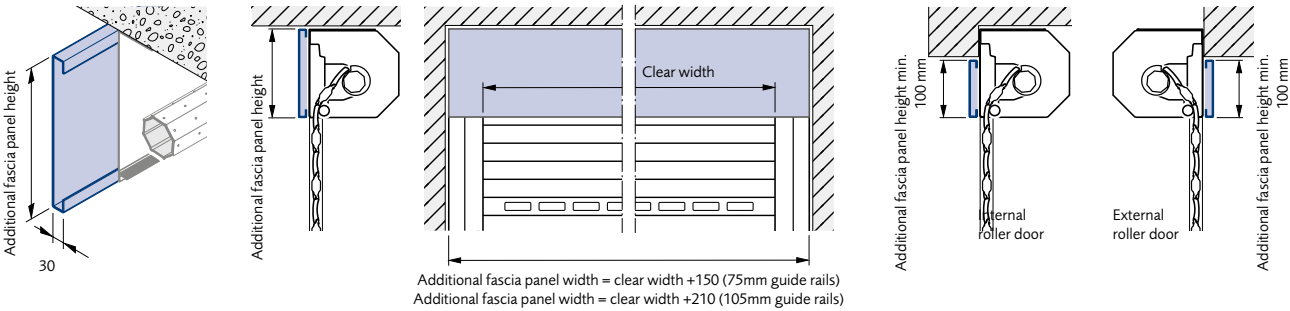
Additional Fascia Panel			
Reinforcement of the fascia panel (required for fitting between opening)		per m ²	106
	Additional fascia panel width = clear width +150 (75mm guide rails) Additional fascia panel width = clear width +210 (105mm guide rails)		
External fit (reverse rolled)*			73
Operator with electronically adjustable end-of-travel positions*			470
Wireless optical sensor			255

Not available in Secured By Design Doors

GaraGlide Roller Doors

DuraBelt is available as an option when purchased with a new GaraGlide, or for retro-fitting to an existing GaraGlide:

DuraBelt (Optional)

1000 mm - 1600 mm wide (2 winding units)		surcharge per door	99
1601 mm - 3000 mm wide (3 winding units)		surcharge per door	146
3001 mm - 5000 mm wide (5 winding units)		surcharge per door	244

DuraBelt (Retro-Fitted)

up to 2300 mm wide (2 winding units)	Part ref: 8995301	per door	148
up to 2300 mm wide (3 winding units)	Part ref: 8995302	per door	223
from 2301 mm wide (2 winding units)	Part ref: 8995303	per door	148
from 2301 mm wide (3 winding units)	Part ref: 8995304	per door	223

Additional options

Preassembled Curtain*			43
Lifting Belts			43
Somfy Operator			309

* Only available up to 3000mm wide and 2300 high

User Information / Care

A Garador garage door needs only a minimum level of preparation and maintenance to give years of trouble-free service. Below is a guide to how to get the best from your garage door.

Operation

- For opening the door in manual operation use only the outside handle or inside handle. Never use the pull rope during the opening cycle of the door.
- For closing the door from the outside – the pull rope fixed to the internal handle is only designed to pull the door towards you whilst standing within the entrance of the garage until the door can be pushed down by hand, then using the external handle for final closing.
- For closing the door from the inside – the pull rope already mentioned is designed to be pulled away from you, when facing the front entrance of the garage, until the internal handle is able to be reached, by hand, and used for final closing. The pull rope is not designed to be used for any other part of the operating cycle, or any other purpose. Failure to comply with the above instructions may result in injury to persons or property.
- When the door is operated from either outside or inside, check the area through which the door will travel is clear from people and objects. Failure to do so may result in injury to persons or property.
- When closing, ensure the latches engage properly.
- If the door is power-operated always try to ensure you match the door with a GaraMatic electric operator.

Power Operated Garage Doors

- It is against the Law to install a power operated garage door in the UK without complying with The Machinery Directive.
- To comply with the Machinery Directive both the door and the operator used in the Installation must have a declaration of Incorporation from the manufacturer.
On completion of the installation the Installer must provide a Declaration of conformity and apply a CE mark giving details of the installation to the door/operator combination, which is now classed as a machine.
- The Installer must issue to the Customer a declaration of conformity on the completion of the installation.
- The Installer must hold copies of both the Declarations of Incorporation and the Declaration of Conformity on a technical file for inspection by the relevant authorities.
- If any of the above requirements are not fulfilled the Installation is illegal.
- Please ensure for your own safety and peace of mind that whoever installs your electric operator is both willing and able to fulfil these requirements; if they are not do not use them !!
- Members of the DHF CAN and WILL install your operator safely and legally.

User Information / Care

Cleaning

- The door and frame if applicable, should be washed with a mild soap-based solution on a regular basis to prevent the build up of dirt, salts and other corrosive substances and help maintain the aesthetic appearance of the product.
- If the door is installed in a coastal location, the door panel and frame should be cleaned in this way at least every two months.
- We also suggest that all other components be brushed down on a regular basis to prevent the build up of dirt and dust etc.
- On GaraRoll roller doors regular removal of dirt and debris is required to avoid damage to laths when the curtain rolls.

Locking

- If the key is turned completely, the door is then locked or unlocked; when unlocked it is then possible to open and close the door by turning the handle.
- If the key is turned 1/4 of the way, the door opened and then the key returned to its start position, the door will re-lock when closed.
- By moving the internal locking "snib", it is possible to lock and unlock the door from the inside without using the key, except on SBD doors where there is no internal snib/locking system.

Maintenance

- If in doubt about any of these maintenance procedures below always consult a Garador specialist. Garador Ltd. has a nationwide network of installers who will be able to offer you a regular maintenance service on your garage door. Please call Garador or refer to the Garador website for further details of your nearest installer.
- Immediately after the door is fitted and after every 5,000 operations of the door, or at least once a year, oil all pivot points, check screws and clamped connections for tightness, keep the running tracks clean (do not grease them), check parts and replace any worn components where necessary.
- The springs should be replaced after approx. 25,000 operations by an experienced door fitter (see fitting and operation instructions).
- Do not oil the lock cylinder; if it is sticking, only lubricate with graphite dust.
- For canopy doors only, check the cable every 6 months with normal usage (8 operations per day). Have the cables replaced by an expert if any wear is found.

User Information / Care

Finish – Steel Doors

The coating process applied to the door and chassis is environmentally friendly. Minor scratches or marks are not covered under the conditions of our warranty and should be repaired immediately to prevent corrosion and deterioration of the panel. Corrosive substances such as acids, alkalines, and salts, etc. should be cleaned from the door immediately; failure to do so will result in deterioration of the finish, which will not be covered under our warranty. Garador steel doors are finished products. They do not require immediate painting on-site. They are however not immune to damage, which can occur at any stage of the handling of the product from factory to site. Should deterioration of the finish start to occur you will need to repaint your door immediately. Prepare the surface lightly with wet and dry. Then treat with solvent based 2 pack epoxy wash primer and a normal commercial paint (cellulose paint must not be used).

Minor surface damage can easily be repaired using touch up sprays or paint sticks without invalidating your warranty.

Finish – Timber Doors

Timber panels are coated with a neutralising base-stain. Doors must be stored upright, under cover in a dry location, with wrapping intact, until wrapping is removed. As soon as the door is unwrapped, one coat of a good quality basecoat primer must be applied to both sides of the door. Immediately after installation, your timber doors require a further two coats of a good quality exterior wood finish on both sides. Initial application and periodic treatment should be carried out strictly in accordance with the woodstain manufacturer's instructions. Failure to follow these instructions will result in early deterioration of the timber panel which would not be covered under our warranty.

Finish – GRP Doors

GRP door panels should be periodically washed down using water. This should be done more frequently if fitted in a coastal location.

Bird droppings will bleach the finish on GRP and should be removed using water as soon as possible.

GRP doors should not be painted over.

Warranty

Garador products are manufactured to the highest quality standards and leave our factory only after rigorous quality testing. However, if you should have grounds for complaint, this section tells you what our door warranty offers, and how to go about making your claim.

In the unlikely event of a warranty claim becoming necessary, please contact the dealer or distributor who originally supplied your garage door. Your dealer should then supply details of the claim, together with a copy of the warranty card provided with the door and proof of purchase to the Warranty Department at Garador Ltd.

To enable your claim under warranty to be processed as quickly as possible, you should provide the following details:

- 1 Your name, address and telephone number
- 2 Original invoice with date of purchase
- 3 Product description/door type and product number
- 4 Description of defect

An assessment of the claim will then be made. This may require Garador to inspect the product in-situ. In the event that there is no legitimate warranty claim under the terms specified herein, you may be liable for the costs of the inspection visit. We strongly recommend that you take note of the care and usage instructions displayed on the stickers on the back of your garage door and on the previous page and that you follow these instructions throughout.

Garador installers

Garador Ltd. has a nationwide network of recommended installers who will be able to offer you a regular maintenance service on your garage door.

Please call us on 01935 443722 or refer to the Garador website for further details of your nearest installer.

Warranty

Garador Garage Door Warranty

Warranty Period

The purchaser is granted a warranty covering the safe and reliable function of the Garador garage door for a period of 10 years from the date of purchase. A 5 year warranty applies to springs, wire cables, track rollers, hinges and guide rollers. The warranty period for replacement parts is 6 months or to the end of the current warranty period, whichever is longer.

In the case of foil-coated timber effect and PVC doors, a warranty of 5 years is granted, for timber and GRP doors a warranty of 2 years is granted on the door panels alone under the terms and conditions specified herein. The door mechanism and steel frame (if applicable) is covered by the 10 year warranty period.

Requirements

Warranty claims are only applicable in the country where the garage door was purchased. The product must have been purchased through our authorised distribution channels. The warranty only covers damage to the contract object. The fully completed warranty card together with the receipt of purchase correspondingly dated substantiates your right to claim under the warranty.

Performance

During the warranty period we undertake to rectify any and all defects to the Garador product which can be proved to be attributed to a material or manufacturing fault.

We pledge at our discretion either to exchange the defective merchandise for faultless merchandise, repair it or allow a reduction in price. We do not accept costs for dismantling and installation nor for carriage. Replaced parts become our property.

The warranty does not cover damage caused through:

- normal wear and tear
- negligent care and maintenance
- improper initial and subsequent operation
- negligent or wanton destruction
- external influences such as fire, water, salts, alkaline solutions, acids, abnormal environmental influences
- mechanical damage through improper transport and fitting
- priming and other surface protection treatments
- incorrect or too late applied surface protection treatments
- repair by non-qualified persons
- using non-Garador parts without the approval of the manufacturer
- Removal of the product number or making it unidentifiable

Warranty

Warranty GaraRoll and GaraGlide

GaraRoll and GaraGlide roller doors are subject to a limited 10 year warranty. The design of these doors represents state of the art technology. Pressure marks and abrasive wear, particularly on the top profiles are a condition of the design and cannot be avoided. They are not considered a reason for complaint. In order to avoid excessive friction, remove any dirt and debris from the door curtain at regular intervals. For motors and controls, see warranty below.

In addition to the statutory warranty provided by the dealer in the sales contract, we grant the following warranty for parts from the date of purchase:

- 5 years on operator technology, motor and motor control.
- 2 years on radio equipment, accessories and special systems.

Claims made under the warranty do not extend the warranty period. For replacement parts and repairs the warranty period is six months or at least the remainder of the warranty period.

General wear and tear:

Due to the design of the roller door, the inside of the door curtain will exhibit some marks after a short period of time. This is classed as general wear and tear that you would expect to see over a period of months or years. It is not detrimental to the door's performance and would therefore not be grounds for a warranty claim.

Pre-requisites:

The warranty claim only applies in the country where the equipment was purchased. The product must have been purchased through our authorised distribution channels. A claim under this warranty exists only for damage to the object of the contract itself. The receipt of purchase substantiates your right to claim under the warranty.

Services:

For the duration of the warranty we shall eliminate any product defects that are proven to be attributable to a material or manufacturing fault. We pledge to replace free of charge and at our discretion the defective goods with non-defective goods, to carry out repairs, or to grant a price reduction. Replaced parts become our property. Reimbursement of expenditure for dismantling and fitting, testing of parts as well as demands for lost profits and compensation for damages are excluded from the warranty.

Warranty

Damage caused by the following is also excluded:

- improper fitting and connection
- improper initial start-up and operation
- external factors such as fire, water, abnormal environmental conditions
- mechanical damage caused by accidents, falls, impacts
- negligent or intentional destruction
- normal wear or deficient maintenance
- repairs conducted by unqualified persons
- use of non-original parts
- removal or defacing of the data label

Electric Operator Warranty

A separate 5 year warranty is granted on our electric operators. This includes operator mechanics, motor and motor control systems. A 2 year warranty is granted on radio equipment, accessories and system controls. There is no warranty on consumables (e. g. fuses, batteries, bulbs etc.).

For further details please contact us on 01935 443722, or through our website on www.garador.co.uk



Extracts from DHF consumer advice

The following document has been created by the Door and Hardware Federation (DHF) and endorsed by all major UK garage door manufacturers, as a guide for purchasers and domestic garage doors.

Visual Appearance of Garage Doors

A new garage door can be a significant investment that will transform the appearance of your home. This information is a guide to the quality you can expect.

The Quality Check

The quality check should be carried out in natural daylight, not direct sunlight. Stand at a distance of 3 metres from the door to view the overall appearance. The door is acceptable if, taking into account the facts below, none of the following are readily visible on the face of the door:

- Marks or distortion associated with the manufacturing process
- Minor indentations, marks or scuffs on the surface
- Paint or stain blemishes

The Facts

Steel Doors

- Panel Distortion

The rolling or pressing of steel panels during manufacture will cause distortion in the steel and while every effort is made to keep this to a minimum, inevitably some visible distortion will remain. The application of high gloss paints will make this slight distortion more apparent, especially under certain lighting conditions, such as car headlamps, or bright sunshine.

- Paint Finish

Primed doors – the primer coating is applied as a base coat only and as such requires additional finishing with a good quality exterior paint. Any marks or scratches on the primer coat should be rubbed down and repainted as part of this finishing process.

Finished doors – the factory application of the paint finish is an automated process and this may result in minor blemishes or slight inconsistencies in the paint, particularly in the area of panel joints.

Timber Doors

- Timber

Timber is a natural product and there will be variations in pattern, colour, shading and grains. No two doors will be the same. Wood naturally expands and contracts according to environmental conditions, joints will open and close and some minor curvature may occur.

- Finishing

It is vital that timber doors are fully finished as per the manufacturers instructions before exposure to the elements.

Extracts from DHF consumer advice

GRP and composite Plastic Doors

- Mould Marks

GRP doors are individually handcrafted in a mould and are then hand finished. Some minor marks and blemishes will inevitably remain after this process.

- Translucency

When viewed from the inside, it is often possible to see variations in the translucency of the door, particularly around and between areas of relief. Such variations do not detract from the overall strength or build quality of the door.

All Doors

- Colour Match

Pairs of doors should be ordered together to obtain the best colour match, bearing in mind the limitations of the materials used in the construction. Timber garage doors cannot be ordered as matching sets.

- Size Variations

As the size of a door changes in height and/or width, the panel frequency and profile can change, therefore doors of the same style but of different sizes can be significantly different in appearance.

- Clearances

All doors require operating clearances, i.e. the gap between the door panel and the frame opening, these are inbuilt during manufacture and should not be reduced by means of infills, or draughtproofing.

- Deflection

When in the open position, all doors will display a level of vertical deflection or 'sag' across the width of the panel. Individual manufacturers' specifications should be consulted for exact tolerances.

GARADOR

The Garage Door People

Bunford Lane, Yeovil, Somerset, BA20 2GL

Tel: (01935) 443722

sales@garador.co.uk

www.garador.co.uk

Garador is the UK's leading manufacturer of garage doors and operators, with an ultra-modern production facility located in Somerset. We use German engineering expertise to produce highly sophisticated doors and operators. By purchasing a Garador product you can be assured of the highest level of quality, safety and security. With a nationwide network of stockists, installers and service technicians we are an ideal partner for your project.