

NEW  
Concealed  
Hinges!



15  
years

2008-2023

January  
2024

# GARAGE DOOR RANGE PRICE LIST & TECHNICAL GUIDE

All prices exclude VAT and delivery

**TECKENTRUP**  
DOOR SOLUTIONS

# PRICE LIST JANUARY 2024

## WHAT'S IN THIS PRICE LIST?

General Information	2
CarTeck Sectional Garage Doors	4
Matching Side Doors	5
CarTeck Garage Door Automation & Lighting	6
CarTeck Super Size Sectional Garage Doors	7
CarTeck GSA Vision Sectional Garage Doors	8
CarTeck SLX Vision Sectional Garage Doors	9
CarTeck Side Hinged Garage Doors	10
Technical Information	12
Fitters Tips	15
Spares	20

### What does a pink box mean in the price list?

It contains essential information – make sure you read it!

#### PRICING

Prices are in £'s Sterling. This price list supersedes and renders null any previous price list.

#### SIZES

When ordering use metric sizes, imperial conversions are nominal.

#### TERMS

Comprehensive terms and conditions are on line at: [www.teckentrup.co.uk/terms-conditions](http://www.teckentrup.co.uk/terms-conditions)

#### DELIVERY

##### Delivery:

To company premises FOC.

To site £75 nett.

To the Scottish Highlands and Islands on application.

Congestion charges apply subject to post code locations.

#### LEAD-TIMES

Lead times are subject to change and may be affected by the availability of raw materials, border delays and other factors beyond our control.

After placing your order you'll receive a confirmation with the week of delivery.

We work hard to maintain the advised delivery date and any slippage will be notified as soon as we become aware of an issue.

If you need a door for a specific date please call the sales office, we'll do our best to help.



2008-2023

## WHAT PERFORMANCE CAN I EXPECT?

As Part of the UKCA/CE marking process, each product must have its performance provided for a defined set of characteristics. Other characteristics can also be included if relevant to a door's performance, such as security. The following table shows the performance characteristics of each product in our range.

NPD signifies the product has not been measured for this characteristic (NPD - No Performance Determined)

PERFORMANCE CHARACTERISTIC	CarTeck Sectional Garage Doors	CarTeck Super Size Sectional Garage Doors	CarTeck Sectional GSA Vision Garage Doors	CarTeck Sectional SLX Vision Garage Doors	CarTeck Side Hinged Garage Doors
Resistance to Windload EN 12424	Class 2	Class 2	Class 2	Class 2	Class 2
Watertightness EN 12425	Class 2	Class 2	Class 2	Class 2	NPD
Air Permeability EN 12426	Class 2	Class 2	Class 2	Class 2	NPD
Thermal Transmittance EN 13241	1.38 W/m <sup>2</sup> k	1.29 W/m <sup>2</sup> k	3.3 W/m <sup>2</sup> k	3.5 W/m <sup>2</sup> k	2.20 W/m <sup>2</sup> k
Operating Forces (hand Operated) EN 12604	150 N	150 N	150 N	150 N	NPD
Operating Cycles EN 1191	NPD	NPD	NPD	NPD	NPD

## WARRANTY

The warranty periods below only apply to products that have been correctly installed as per the instructions and have been used, maintained by a Garage Door Specialist and cleaned in accordance with the requirements set out in the operating and maintenance sections of instructions and labels.

### CARTECK, SUPER SIZE, GSA VISION & SLX VISION SECTIONAL GARAGE DOORS

#### 2-year manufacturer's guarantee

- on polymer and aluminium window units

#### 5\*-year manufacturer's guarantee

- on SLX & GSA Vision windows, rollers, hinges, cable pulleys, cables and standard springs (opening/closing max. 5 times a day)

#### 10-year manufacturer's guarantee

- on panels against rust penetration from inside to outside
- against door panel separation of steel from foam
- on material and manufacturing flaws of all non-moving parts of the frame that are verifiably unusable or whose usability is substantially compromised
- on floor seal, intermediate seals, side seals and lintel seal against rotting

The guarantee does not apply to doors that are subjected to extreme conditions, e.g. corrosive influences resulting from use in a coastal climate with high salt content.

**\*2 -year for Super Size**

### CARTECK SIDE HINGED GARAGE DOORS

#### 2-year manufacturer's guarantee

- on window units, hinges, locks, handles and stays (opening/closing max. 5 times a day)

#### 10-year manufacturer's guarantee

- on panels against rust penetration from inside to outside
- against door panel separation of steel from foam
- on material and manufacturing flaws of all non-moving parts of the frame that are verifiably unusable or whose usability is substantially compromised
- on floor seal, intermediate seals and frame seals against rotting

The guarantee does not apply to doors that are subjected to extreme conditions, e.g. corrosive influences resulting from use in a coastal climate with high salt content.

### CARTECK DRIVE & MOTOR

#### \*5-year manufacturer's guarantee

- on mechanical defects, material and manufacturing flaws. (opening/closing max. 5 times a day)\*\*

#### \*1 -year for Super Size

\*\* Consumable Items are not included within warranty terms and conditions: hand transmitters, light bulbs, fuses & batteries.

## HANDLING

CarTeck Sectional Doors are delivered flat-packed & CarTeck Side Hinged Doors are delivered complete. Both are heavy and require suitable consideration for safe handling.

CarTeck Super Size Sectional, CarTeck GSA Vision & CarTeck SLX Vision are delivered crated. Suitable arrangements for safe handling at delivery and onward transportation must be considered.

## CLEANING ON INSTALLATION

After the installation has been completed, clean and dry the door thoroughly inside and out with warm soapy water to remove any grease, dust and metal fragments from the door (these will discolour the door finish if left on the door).

## MAINTENANCE

Doors must be maintained as per the supplied Installation, Operating and Maintenance Manual by a Garage Door Specialist. Failure to carry out the required maintenance at the advised interval will invalidate the warranty.

## CLEANING

The door should be washed with a car shampoo or similar, every two months, to prevent the build up of dirt, salt, grit and other corrosive substances. If the door is in an area prone to coastal corrosion from airborne salts, the door should be cleaned monthly. Furthermore, cleaning lifting gear with a cloth soaked in a light oil will help to protect your door from corrosion – it must be accepted that salt air is very aggressive and extra care is required.

No caustic, abrasive or corrosive chemicals and substances, flood water, water runoff, or runoff from lead, copper or galvanic metal flashing should be allowed to come into contact with the door. Contaminants can lead to oxidation spots on the external face of the door. Windows that have a mock lead effect may show a white residue due to oxidation over time, this should be removed should it contact painted surfaces.

Ash, cement, dust, animal waste, or foreign substances should be removed immediately. Failure to ensure the door is cleaned and maintained as described will invalidate the doors' warranty.

For more information on what performance you can expect from your garage door, visit the Honesty Page on the Teckentrup website -

[www.teckentrup.co.uk/garage-doors/the-honesty-page](http://www.teckentrup.co.uk/garage-doors/the-honesty-page)



**TECKENTRUP**  
DOOR SOLUTIONS <sub>3</sub>

# CARTECK SECTIONAL GARAGE DOORS GSW 40-L

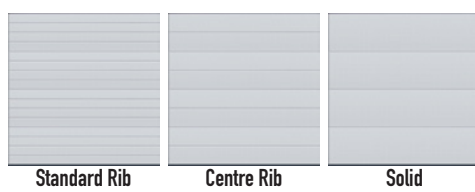

Intermediate height or width or combination: Next size + £177		Standard Widths	2084	2134	2235	2286	2388	2438	2591	2743	3048	3353	3658	3962	4216	4267	4420	4572	4877	5182	5500			
		Maximum Height mm	3000	3000	3000	3000	3000	3000	3000	3000	3000	3000	3000	3000	3000	3000	3000	2875	2625	2500	2500			
<b>4</b> Sections Max 4 section height 2280	1875 6'2"	2050 6'9"	2175 7'2"	White		1477	1477	1480	1480	1570	1570	1697	1850	2003	2155	2308	2460	2509	2561	2650	2669	2822	2973	3278
	1925 6'4"	2084 6'10"	2204 7'3"	Wood/Trend/Trend+		1623	1623	1638	1638	1731	1731	1860	2026	2190	2356	2521	2688	2849	2861	2927	3099	3266	3429	3762
	2000 6'6"	2125 7'0"	2250 7'4"	RAL		1955	1955	1967	1967	2081	2081	2240	2442	2642	2842	3042	3243	3443	3441	3526	3733	3932	4132	4532
<b>5</b> Sections Max 5 section height 2835	2375 7'9"	2750 9'0"	White		1827	1827	1977	1977	2098	2098	2262	2466	2669	2872	3075	3277	3344	3412	3481	3554	3757	3959	4401	
	2500 8'2"	Wood/Trend/Trend+		2230	2230	2234	2234	2371	2371	2555	2784	3010	3241	3469	3697	3773	3849	3925	4006	4236	4464	4952		
	2625 8'9"	RAL		2445	2445	2462	2462	2604	2604	2803	3053	3302	3554	3803	4053	4304	4301	4406	4664	4913	5163	5714		
<b>6</b> Sections	2875 9'5"	White		2627	2627	2633	2633	2794	2794	3009	3279	3552	3821	4090	4362	4450	4540	4629	4724	4837	-	-		
	3000 9'9"	Wood/Trend/Trend+		2963	2963	2968	2968	3154	3154	3394	3698	4001	4307	4611	4913	5015	5114	5213	5323	5441	-	-		
	RAL		3318	3318	3336	3336	3509	3509	3743	4045	4345	4646	4947	5245	5546	5545	5668	5977	6104	-	-			

FRAME LEG/HEADER COLOUR		White	0	0	0	0	0	0	0	0	0	0	0	0	0	0	0	0	0	0	0
Door price includes white frame legs and header. For colour matched frame legs & header add:		Wood/Trend/Trend+	71	72	75	76	80	81	84	91	101	110	119	129	139	140	144	150	159	167	180
Please specify back fix frame or between fix (no holes) frame		RAL	309	313	320	326	332	336	349	362	386	410	432	456	478	482	494	507	517	531	581

WINDOWS		White	429	429	429	429	429	429	429	429	429	429	572	572	572	715	715	715	715	715	858	858	1001
Polymer Windows (type 1 Rectangle)		Trend / Trend + / RAL / Wood Design	561	561	561	561	561	561	561	561	561	561	748	748	748	935	935	935	935	935	1122	1122	1309

BETWEEN FIX ACCESSORIES		Width	<=3000mm	>3000mm
85mm Frame Leg 3D Profile Kit		White	133	133
85mm x 12mm x 3000mm 3D Legs		Wood/Trend/Trend+	133	133
		RAL	220	220
85/120mm Frame 3D Profile Kit		White	220	292
85mm x 12mm x 3000mm 3D Legs		Wood/Trend/Trend+	220	292
120mm x 12mm x 3000mm 3D Header		RAL	350	465
120mm Frame 3D Profile Kit		White	242	320
120mm x 12mm x 3000mm 3D Legs & 3D Header		Wood/Trend/Trend+	263	350
		RAL	350	465
85mm 3D Frame Leg & Additional Door Header		White	262	353
85mm x 12mm x 3000mm 3D Legs		Wood/Trend/Trend+	284	382
Additional Door Header to Width of Door		RAL	351	495
120mm 3D Frame Leg & Additional Door Header		White	284	381
120mm x 12mm x 3000mm 3D Legs		Wood/Trend/Trend+	328	440
Additional Door Header to Width of Door		RAL	404	570
70mm Angle 3D Renovating Profile		White	242	320
Kit 70mm x 12mm x 3000mm 3D Legs & 3D Header		Wood/Trend/Trend+	263	350
		RAL	350	465

>3000mm 3D headers require a butt joint

## POPULAR OPTIONS

ACCESSORIES AND OPTIONS (For spares see back page)		
Manual locking including detent (factory prepared) 5000mm Max		£157 each
Manual locking including detent (onsite with template) 5000mm Max		£85 each
L shaped fixing strap kit		£26 pair
Between reveal fitting bracket kit (When using a between the reveal fitting kit, the sideroom required is 85mm) Kit includes 10 brackets.		£81 kit
Between reveal twist fix header bracket (2x) kit (Recommended for doors over 3000mm wide)		£34 kit
Horizontal track cut down charge		£176 per set
240mm headroom kit		£0
Sloping bottom panel (take largest height) add to door price		25%

## MATCHING SIDE DOORS

Maximum Over-Frame Size Height		Width up to 1250mm		
Up to 2050 4 Section	White	1728	1902	Solid, Centre Ribbed & Standard Ribbed Side Doors
	Wood/Trend/Trend+	2144	2289	
	RAL	2359	2532	
Up to 2204 4 Section	White	1815	1998	Georgian Side Doors
	Wood/Trend/Trend+	2200	2383	
	RAL	2446	2629	
Up to 2204 4 Section	White	1906	2097	Georgian Side Doors
	Wood/Trend/Trend+	2293	2482	
	RAL	2538	2728	

### Georgian Features

Georgian design door widths of 2080mm and below have 2 features and come with an increase lead time – call the office for details.

### Frame Legs, Headers & 3D Profiles

Frame legs/head – 85mm/115mm smooth & white as standard. For Trend, RAL or Wood Design, add the uplift to the white price.

Wood Design frame legs, headers & 3D profiles in Night Oak & Rosewood are finished in a complimenting painted wood effect finish but will not match precisely. Golden Oak and Winchester are finished in a complementary flat colour to RAL 8014. Golden Oak frame & header slip-over covers are available as an option – use the 3D cover price. T19016 Bling White frame legs, headers & 3D profiles are finished in RAL 9016.

All frame Legs, headers & 3D profiles are available in smooth finish only.

Between fix (No Holes) frames up to 2250mm high maximum.

# POLYMER WINDOWS

WINDOWS - POLYMER DOUBLE GLAZING Polymer casement with polymer (Styrene Acrylonitrile) double glazed unit.

## Georgian



Rectangle 1 Plain    Rectangle 1 Cross Mullion    Rectangle 1 Rhombus

## Standard Rib, Centre Rib & Solid



Rectangle 1 Plain    Rectangle 1 Cross Mullion    Rectangle 1 Rhombus    Rectangle 2    Rectangle 3    Vertical Square 1    Vertical Square 2    GSA Aluminium

Style	Overall Size	Colour / Finish	Price
Rectangle 1	610 X 270	White Trend/Trend+/Ral/Wood design	£143 each £187 each
Rectangle 2	680 X 210	White Trend/Trend+/Ral/Wood design	£143 each £187 each
Rectangle 3	980 X 140	White Trend/Trend+/Ral/Wood design	£171 each £224 each
Square 1 & 2	270 x 270	White Trend/Trend+/Ral/Wood design	£143 each £187 each
GSA Aluminium Window Section	per linear m	White/Trend/Trend+ Ral/Wood design	£519 per m £779 per m

All polymer windows are available with these glazing options:

\*The exterior pane is Frosted/Satin and the interior pane is Clear.



### Polymer Windows

To price for windows fitted vertically down the door; square type 1 & 2, match windows to number of sections ie 4 sections = 4 windows).

Selected Trend colours & wood design windows are finished in a complementary flat colour for Golden Oak (RAL8003), Rosewood (RAL8016), Night Oak (RAL8014), Winchester RAL8001), Textured Anthracite (RAL7016), Ice Crystal Grey Aluminium (RAL9007) and TT9016 Bling White (RAL9016).

The surrounds on aluminium GSA window sections are finished in a smooth finish. Window frame colour shade and surface lustre will show a variance from the panel finish as the base material and coating methods are different.

Polymer glazing in Georgian doors and Type 2 rectangle is 16mm thick. All other polymer glazing is 20mm thick.

# ALUMINIUM WINDOWS & DECALS

ALUMINIUM WINDOWS - POLYMER DOUBLE GLAZING Aluminium and polymer casement with polymer double glazed unit.

### PRICE PER WINDOW

£352



Alpha  
280mm x 280mm



Sigma  
610mm x 200mm



Zeta  
ø280mm



Gamma  
534mm x 344mm

### PRICE PER SET

£844



Kappa  
1860mm x 180mm



Athena  
406mm x 203mm



Versus  
900mm x 1000mm

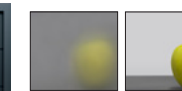

Satin    Clear

All aluminium windows are available with these glazing options (satin is supplied as standard).

ALUNOX DECALS Factory bonded alunox decals. Decals can be positioned to requested positions, however, popular arrangements are shown here.

### PRICE PER DECAL

£61



Access 1  
431mm x 40mm



Access 2  
430mm x 40mm



Access 3  
215mm x 40mm



Access 4  
400mm x 86mm

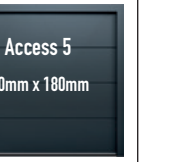

Access 5  
180mm x 180mm

### PRICE PER DECAL

£61



Access 6  
70mm x 70mm



Access 7  
150mm x 150mm

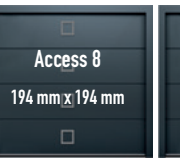

Access 8  
194mm x 194mm



Access 9  
436mm x 40mm



Access 10  
431mm x 13mm

### PRICE PER DECAL

100mm £55  
200mm £61



Writing  
100mm    200mm

### EXTRA TOUCHES

#### PET FLAP

£48 fitting charge\*

\*Customer supplied

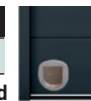

#### SPY HOLE

£55



#### LETTER BOX

From £83



## TREND COLOURS

TT9016 Bling White with micaceous iron ore particles glitter effect	Ice Crystal Grey Aluminium	White Aluminium RAL 9006	Grey Aluminium RAL 9007	Light Grey RAL 7035
Window Grey RAL 7040	Quartz Grey RAL 7039	Umbra Grey RAL 7022	Slate Grey RAL 7015	Anthracite Grey RAL 7016
*Anthracite Textured RAL 7016	TT 703 A special satin metallic effect (grey with micaceous iron ore particles)	Jet Black RAL 9005	Steel Blue RAL 5011	Moss Green RAL 6005
Fir Green RAL 6009	Flame Red RAL 3000	Sepia Brown RAL 8014	Cream RAL 9001	

\*Only available on smooth surface texture.

## NEW! TREND+ COLOURS

Agate Grey RAL 7038	Silver Grey RAL 7001	Pebble Grey RAL 7032	Stone Grey RAL 7030	Mouse Grey RAL 7005
Basalt Grey RAL 7012	Graphite Grey RAL 7024	Granite Grey RAL 7026	Graphite Black RAL 9011	Signal Black RAL 9004
Gentian Blue RAL 5010	Pigeon Blue RAL 5014	Chartwell Green BS 14 C 35	Sage Green RAL 130 60 10	Burgundy RAL 3004
Ruby Red RAL 3003	Terra Brown RAL 8028	Nut Brown RAL 8011	Light Ivory RAL 1015	Pure White RAL 9010

### Colours

Where doors are exposed to direct sunlight, dark colours should be avoided.

RAL/BS references for colours are provided as a guide only to the nearest similar RAL/BS colour. Colours will not match to other RAL/BS finishes due to different coating processes, gloss levels, substrates and textures. Similarly, special RAL, BS, wood effects or other colours will not be a precise match.

Colours shown are limited in accuracy by the printing process - samples should always be requested.

If you are matching to other finishes, particularly wood effects such as rosewood, golden oak, night oak or Winchester, always request a sample.

# DOOR DRIVES

# CarTeck DRIVE<sup>+</sup>

## CARTECK DRIVE



Drive 500 / 600



Drive Pro 500 / 600

Drives require 140mm headroom. To fit within 120mm use the Spacer Bar Suspension Plate that lowers the rear spacer bar by 40 mm

Drive 500Nm & 2 x Pearl Twin	£416
Drive Pro 500Nm & 2 x Pearl Twin	£474
Drive 600Nm & 2 x Pearl	£453
Drive Pro 600Nm & 2 x Pearl	£500
Rail extension 1096mm (heights greater than 2375mm) add	£113
Spacer bar suspension plate (for 120mm headroom)	£34



## CARTECK DRIVE ACCESSORIES

Post & packing may apply to accessories not ordered with a door

Description	Price	Compatibility	
		500	600
2-function handheld transmitter „Pearl Twin“	£74	•	•
4-function handheld transmitter „Pearl“	£87	•	•
3-function handheld transmitter „Pearl status“	£113	•	•
4-function handheld transmitter „Pearl vibe“	£160	•	•
Holding clip for pearl transmitter for sun shield	£15	•	•
Holder Pearl for mounting pearl transmitter white or black	£22	•	•
868 MHz Radio receiver (2-channel)	£159	•	•
Access Pack 1: Keypad (without Courier function)	£260	•	•
Access Pack 2: wireless 2 function wall switch white or grey	£113	•	•
Access Pack 3: Surface mounted keypad	£444	•	•
Access Pack 4: Keypad with Courier function, includes safety pack 1	£275	•	•
Wired 3 function internal wall station	£55	•	•
Safety Pack 1 Photo cell kit (Includes mounting kit if required)	£145	•	•
Additional light strip attaches to control unit	£61	•	•
Ambience pack 1: light strip & motion sensor	£122	•	•
Ambience pack 2: relay to control lighting	£41	•	•
Parking Pack 1: position laser & reflector	£94	•	•
Parking Pack 2: humidity sensor	£36	•	•
Security pack 1: lock & alarm buzzer	£98	•	•
Security pack 2: alarm buzzer & lighting control relay	£127	•	•
Power pack: battery backup	£228	•	•
Smart pack: output module for smart home integration <small>Third party equipment may be required.</small>	£159	•	•
External release for garages without a second entrance	£61	•	•
Special 101 towing arm bracket	£130	•	•

Featured Accessories



1500 lumen/m neutral white 4000K light.

### Ambience Pack 4

Compatibility

Price 500 600

Light bars with stand-alone power supply and motion detector

Width up to 2220mm	£380	•	•
Width up to 3205mm	£490	•	•
Width up to 4190mm	£505	•	•
Width up to 5528mm	£735	•	•
Link to Amazon Alexa - Smart Home*	£115	•	•

\*Only compatible with Ambience pack 4. Third party equipment may be required.

Ambience Pack 3 LED strips for tracks and spacer bar Price 500 600

3rd generation ambience pack 3: 2 x threads (left/right) 2m and 1m of LED lights, motion sensor & remote control	£305	•	•
--	------	---	---

NEW!



SOMweb Smart Phone Module with Safety Photo Cells

Allows control of up to 10 doors

£462 • •

SOMweb is required to interface with smart home systems such as Google Home, Apple Homekit and Amazon Alexa (does not require additional 3rd party equipment)



## CARTECK MOTOR



Flexible installation orientation



300 series



200 series

Add your rail

Motor Head	Price	3286mm	3536mm	4296mm
260	£292	+£111	+£175	+£209
270	£341	+£111	+£175	+£209
280	£415	+£111	+£175	+£209
360	£444	+£111	+£175	+£209
370	£515	+£111	+£175	+£209
380	£701	+£111	+£175	+£209

## CARTECK MOTOR ACCESSORIES

Post & packing may apply to accessories not ordered with a door

Battery back up for 300 series up to 5 cycles	£261	Photocells	£145
Transmitter 2 channel	£84	External receiver 1 channel	£208
Transmitter 4 channel	£100	Digital key pad	£175
Transmitter 3 channel bidirectional	£142	Push button wireless	£80
External release for garages without a second entrance	£61	Special 101 towing arm bracket	£130

# SUPER SIZE SECTIONAL GARAGE DOORS



Pricing includes Motor:

CarTeck DRIVE Pro 1100 rail operator or Teckentrup Direct Drive, optical safety edge, photocells, 2 transmitters & 1 pair of tension bars

Heights up to:

Heights up to:		Widths up to:		6000	6500	7000	7500	8000
<b>4</b> Sections	2280	Rail Operator	White/Wood/Trend RAL	6726	7845	-	-	-
		Direct Drive	White/Wood/Trend RAL	7552	8591	9664	10096	10534
<b>5</b> Sections	2835	Direct Drive	White/Wood/Trend RAL	8179	9426	10672	11176	11679
			RAL	9033	10352	11670	12245	12820
<b>6</b> Sections	3000	Direct Drive	White/Wood/Trend RAL	8467	9839	11175	11714	12255
			RAL	9399	10850	12263	12881	13499
			Number of windows	8	8	9	9	10
Polymer Windows (type 1 Rectangle)			White	1144	1144	1287	1287	1430
			Trend/Wood/RAL	1496	1496	1683	1683	1870

## OPTIONS

Low Headroom up to 6500mm	£ 411
Low Headroom 6501mm - 7750mm	£ 567

## TREND COLOURS

TT9016 Bling White with micaceous iron ore particles glitter effect	Ice Crystal Grey Aluminium	White Aluminium RAL 9006	Grey Aluminium RAL 9007
Light Grey RAL 7035	Window Grey RAL 7040	Quartz Grey RAL 7039	Umbra Grey RAL 7022
Slate Grey RAL 7015	Anthracite Grey RAL 7016	*Anthracite Textured RAL 7016	TT 703 A special satin metallic effect (grey with micaceous iron ore particles)
Jet Black RAL 9005	Steel Blue RAL 5011	Moss Green RAL 6005	Fir Green RAL 6009
Flame Red RAL 3000	Sepia Brown RAL 8014	Cream RAL 9001	*Only available on smooth surface texture.

## Colours

Where doors are exposed to direct sunlight, dark colours should be avoided.

RAL references for colours are provided as a guide only to the nearest similar RAL colour. Colours will not match to other RAL finishes due to different coating processes, gloss levels, substrates and textures. Similarly, special RAL, BS, wood effects or other colours will not be a precise match.

Colours shown are limited in accuracy by the printing process - samples should always be requested.

If you are matching to other finishes, particularly wood effects such as rosewood, golden oak, night oak or Winchester, always request a sample.

# POLYMER WINDOWS

WINDOWS - POLYMER DOUBLE GLAZING Polymer casement with polymer (Styrene Acrylonitrile) double glazed unit.

Style	Overall Size	Colour / Finish	Price per Window
Rectangle 1	610 X 270	White	£143 each
		Trend/Ral/Wood design	£187 each
Rectangle 2	680 X 210	White	£143 each
		Trend/Ral/Wood design	£187 each
Rectangle 3	980 X 140	White	£171 each
		Trend/Ral/Wood design	£224 each
Square 1 & 2	270 x 270	White	£143 each
		Trend/Ral/Wood design	£187 each
GSA Aluminium Window Section	per linear m	White/Trend	£519 per m
		Ral/Wood design	£779 per m

## Polymer Windows

To price for windows fitted vertically down the door, square type 1 & 2, match windows to number of sections ie 4 sections = 4 windows).

Selected Trend colours & wood design windows are finished in a complementary flat colour for Golden Oak (RAL8003), Rosewood (RAL8016), Night Oak (RAL8014), Winchester (RAL8001), Textured Anthracite (RAL7016), Ice Crystal Grey Aluminium (RAL9007) and TT9016 Bling White (RAL9016).

The surrounds on aluminium GSA window sections are finished in a smooth finish.

Window frame colour shade and surface lustre will show a variance from the panel finish as the base material and coating methods are different.

Polymer glazing in Type 2 rectangle is 16mm thick. All other polymer glazing is 20mm thick.

All polymer windows are available with these glazing options:

\*The exterior pane is Frosted/Satin and the interior pane is Clear.

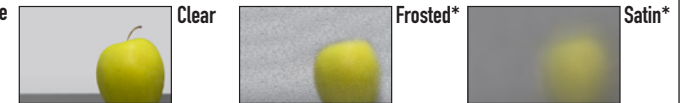

Teckentrup Direct Drive motors must have 13 amp supply direct to the consumer unit.



# CARTECK SECTIONAL GARAGE DOORS GSA VISION



## GSA Vision Options

Sectional door panels made from hollow aluminium profiles, 40mm profile depth with 20mm scratch resistant, polymer double glazing.

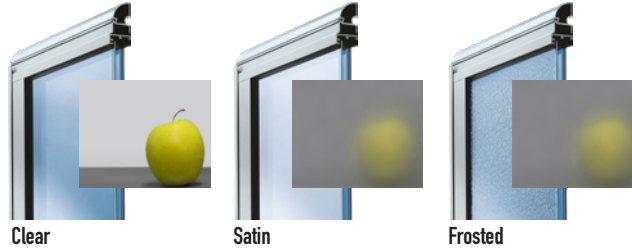

## MATCHING SIDE DOORS

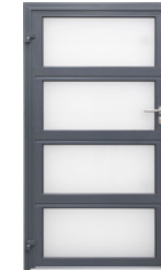

GSA Vision double leaf doors are available - double the prices right.

Height*	*Maximum Over-Frame Size		Single leaf Up to 1250
	Width*		
Up to 2050 4 Section	Trend	4900	5151
	RAL		
Up to 2204 4 Section	Trend	4991	5242
	RAL		
Up to 2320 5 Section*	Trend	5086	5335
	RAL		

Doors are prepared for automation as standard (manual locking not available)

Heights up to:

Sections	Height	Widths up to:																				
		2084 6'10"	2134 7'0"	2235 7'4"	2286 7'6"	2388 7'10"	2438 8'0"	2591 8'6"	2743 9'0"	3048 10'0"	3353 11'0"	3658 12'0"	3962 13'0"	4216 13'10"	4267 14'0"	4420 14'6"	4572 15'0"	4877 16'0"	5182 17'0"	5500 18'0"		
4	2280	White/Trend	5603	5603	5603	5688	5766	6244	6244	6255	6588	6780	7273	7444	7606	7779	7779	8261	8674	8847	9009	
		RAL	6634	6634	6634	6728	6820	6820	7413	7425	7799	8007	8612	8792	8979	9167	9761	9774	10201	10389	10561	
5	2835	White/Trend	6844	6844	6844	6950	7044	7643	7643	7652	8068	8270	8881	9094	9560	9774	9774	10375	10586	10799	11002	
		RAL	8135	8135	8135	8250	8365	8365	9105	9116	9580	9801	10556	10778	11275	11509	12250	12264	12494	12728	12941	
6	3000	White/Trend	8042	8042	8042	8167	8282	9001	9001	9009	9503	10021	10752	11005	11244	11497	11497	12218	12468	-	-	
		RAL	9589	9589	9589	9729	9865	9865	10755	10763	11319	11862	12762	13028	13303	13584	14471	14484	14760	-	-	
		Number of windows	2	2	2	3	3	3	4	4	4	4	5	5	5	5	5	6	6	6	6	
			2250mm			2500mm			3500mm				4500mm				5500mm					
		Frame Leg/Header Colour	White	0	0	0	0	0	0	0	0	0	0	0	0	0	0	0	0	0	0	
			Trend	71	72	75	76	80	81	84	91	101	110	119	129	139	140	144	150	159	167	180
			RAL	309	313	320	326	332	336	349	362	386	410	432	456	478	482	494	507	517	531	581

## Frame Legs, Headers & 3D Profiles

Frame legs/head - 85mm/115mm smooth & white as standard.

All frame Legs, headers & 3D profiles are available in smooth finish only.

Between fix (No Holes) frames up to 2250mm high maximum.

>3000mm 3D headers require a butt joint

## BETWEEN FIX ACCESSORIES

Accessories	Width	
	<=3000mm	>3000mm
85mm Frame Leg 3D Profile Kit	White	133
	Trend	133
	RAL	220
85mm x 12mm x 3000mm 3D Legs	White	220
	Trend	220
	RAL	292
85/120mm Frame 3D Profile Kit	White	220
	Trend	220
	RAL	465
120mm Frame 3D Profile Kit	White	242
	Trend	263
	RAL	350
120mm x 12mm x 3000mm 3D Legs & 3D Header	White	242
	Trend	263
	RAL	465
85mm 3D Frame Leg & Additional Door Header	White	262
	Trend	284
	RAL	495
85mm x 12mm x 3000mm 3D Legs Additional Door Header to Width of Door	White	262
	Trend	284
	RAL	495
120mm 3D Frame Leg & Additional Door Header	White	284
	Trend	328
	RAL	570
120mm x 12mm x 3000mm 3D Legs Additional Door Header to Width of Door	White	284
	Trend	328
	RAL	570
70mm Angle 3D Renovating Profile	White	242
	Trend	263
	RAL	350
Kit 70mm x 12mm x 3000mm 3D Legs & 3D Header	White	242
	Trend	263
	RAL	465

## TREND COLOURS

NOTE: Flat colours only

White RAL 9016	White Aluminium RAL 9006	Grey Aluminium RAL 9007	Light Grey RAL 7035
Window Grey RAL 7040	Quartz Grey RAL 7039	Umbra Grey RAL 7022	Slate Grey RAL 7015
Anthracite Grey RAL 7016	Jet Black RAL 9005	Steel Blue RAL 5011	Moss Green RAL 6005
Fir Green RAL 6009	Flame Red RAL 3000	Sepia Brown RAL 8014	Cream RAL 9001

## Colours

Where doors are exposed to direct sunlight, dark colours should be avoided.

RAL references for colours are provided as a guide only to the nearest similar RAL colour. Colours will not match to other RAL finishes due to different coating processes, gloss levels, substrates and textures. Similarly, special RAL, BS or other colours will not be a precise match.

Colours shown are limited in accuracy by the printing process - samples should always be requested.

## POPULAR OPTIONS

### ACCESSORIES AND OPTIONS

L shaped fixing strap kit	£26 pair
Between reveal fitting bracket kit (When using a between the reveal fitting kit, the sideroom required is 85mm)	£81 kit
Between reveal twist fix header bracket (2x) kit (Recommended for doors over 3000mm wide)	£34 kit
Horizontal Track cut down charge	£176 per set
240mm headroom kit	£0

For the full range of spares/accessories see back page.



# CARTECK SECTIONAL GARAGE DOORS SLX VISION



Full width glazing up to 3250mm wide (no mullions)



Single mullion over 3250mm wide

Doors are prepared for automation as standard (manual locking not available)

Heights up to:

Sections	Height	Widths up to:		Maximum Height mm													
		2084	2134	2235	2286	2388	2438	2591	2743	3048	3353	3658	3962	4000			
4	2280	White/Trend	5603	5603	5603	5688	5766	6244	6244	6255	6588	6780	7273	7444	7606		
		RAL	6634	6634	6634	6728	6820	6820	7413	7425	7799	8007	8612	8792	8979		
5	2835	White/Trend	6844	6844	6844	6950	7044	7643	7643	7652	8068	8270	8881	9094	9560		
		RAL	8135	8135	8135	8250	8365	8365	9105	9116	9580	9801	10556	10778	11275		
6	3000	White/Trend	8042	8042	8042	8167	8282	9001	9001	9009	9503	10021	10752	11005	11244		
		RAL	9589	9589	9589	9729	9865	9865	10755	10763	11319	11862	12762	13028	13303		

Number of windows	1	1	1	1	1	1	1	1	1	1	2	2	2	2
3250mm														

## FRAME LEG/HEADER COLOUR

Door price includes white frame legs and header. For colour matched frame legs & header add: Please specify back fix frame or between fix (no holes) frame

Colour	0	0	0	0	0	0	0	0	0	0	0	0	0	0
White	0	0	0	0	0	0	0	0	0	0	0	0	0	0
Trend	71	72	75	76	80	81	84	91	101	110	119	129	139	139
RAL	309	313	320	326	332	336	349	362	386	410	432	456	478	478

>3000mm 3D headers require a butt joint

## BETWEEN FIX ACCESSORIES

Accessory	Width	
	<=3000mm	>3000mm
85mm Frame Leg 3D Profile Kit	White 133	133
85mm x 12mm x 3000mm 3D Legs	Trend 133	133
	RAL 220	220
	85/120mm Frame 3D Profile Kit	White 220
85mm x 12mm x 3000mm 3D Legs 120mm x 12mm x 3000mm 3D Header	Trend 220	292
	RAL 350	465
	120mm Frame 3D Profile Kit	White 242
120mm x 12mm x 3000mm 3D Legs & 3D Header	Trend 263	350
	RAL 350	465
	85mm 3D Frame Leg & Additional Door Header	White 262
85mm x 12mm x 3000mm 3D Legs Additional Door Header to Width of Door	Trend 284	382
	RAL 351	495
	120mm 3D Frame Leg & Additional Door Header	White 284
120mm x 12mm x 3000mm 3D Legs Additional Door Header to Width of Door	Trend 328	440
	RAL 404	570
	70mm Angle 3D Renovating Profile	White 242
Kit 70mm x 12mm x 3000mm 3D Legs & 3D Header	Trend 263	350
	RAL 350	465

## TREND COLOURS

NOTE: Flat colours only

White RAL 9016	White Aluminium RAL 9006	Grey Aluminium RAL 9007	Light Grey RAL 7035
Window Grey RAL 7040	Quartz Grey RAL 7039	Umbra Grey RAL 7022	Slate Grey RAL 7015
Anthracite Grey RAL 7016	Jet Black RAL 9005	Steel Blue RAL 5011	Moss Green RAL 6005
Fir Green RAL 6009	Flame Red RAL 3000	Sepia Brown RAL 8014	Cream RAL 9001

## Colours

Where doors are exposed to direct sunlight, dark colours should be avoided. RAL references for colours are provided as a guide only to the nearest similar RAL colour. Colours will not match to other RAL finishes due to different coating processes, gloss levels, substrates and textures. Similarly, special RAL, BS or other colours will not be a precise match. Colours shown are limited in accuracy by the printing process - samples should always be requested.

## VISION OPTIONS

Sectional door panels made from hollow aluminium profiles, 40mm profile depth with 20mm scratch resistant, polymer double glazing.

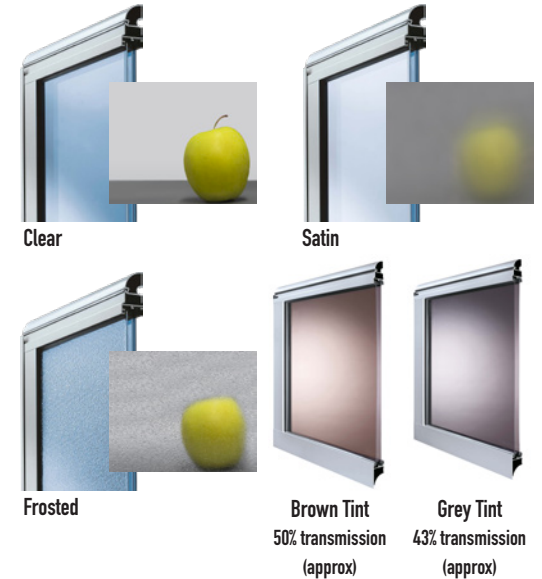

## Frame Legs, Headers & 3D Profiles

Frame legs/head - 85mm/115mm smooth & white as standard. All frame Legs, headers & 3D profiles are available in smooth finish only. Between fix (No Holes) frames up to 2250mm high maximum.

## POPULAR OPTIONS

### ACCESSORIES AND OPTIONS

L shaped fixing strap kit	£26 pair
Between reveal fitting bracket kit (When using a between the reveal fitting kit, the sideroom required is 85mm)	£81 kit
Between reveal twist fix header bracket (2x) kit (Recommended for doors over 3000mm wide)	£34 kit
Horizontal Track cut down charge 240mm headroom kit	£176 per set £0

For the full range of spares/accessories see back page.

# CARTECK SIDE HINGED GARAGE DOORS GSW 40-L

All styles available 1/2 - 1/2 or Asymmetric

All doors include a raised aluminium threshold for improved weather protection

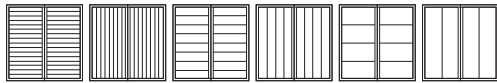

Golden Oak  
Rosewood  
Night Oak  
Winchester



Georgian  
Horizontal & Vertical

Golden Oak  
Rosewood  
Night Oak  
Winchester

**NEW**  
Concealed Hinges!

**NEW!** Widths up to 3188mm over-frame size

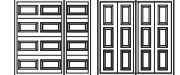

Minimum single leaf 850mm  
Minimum double leaf 1350mm

**NEW!** Widths up to 3188mm over-frame size



Maximum Over-Frame Size		50/50 split only						
Height	Width up to:	1250	2286	2438	2500	2750	3000	3188
Up to 2050 4 Section	White	1728	2477	2589	2712	2976	3279	3385
	Wood/Trend Trend+	2114	2895	3009	3131	3394	3698	3804
	RAL	2359	3176	3291	3410	3674	3978	4083
Up to 2204 4 Section	White	1815	2589	2707	2840	2976	3279	3385
	Wood/Trend Trend+	2200	3009	3126	3259	3523	3827	3932
	RAL	2446	3291	3406	3538	3802	4147	4211
Up to 2320 4 Section Up to 2359 5 Section	White	1906	2712	2840	3021	3285	3588	3694
	Wood/Trend Trend+	2293	3131	3259	3441	3705	4008	4114
	RAL	2538	3410	3538	3719	3983	4287	4392

Maximum Over-Frame Size		50/50 split only						
Height	Width up to:	1250	2286	2438	2500	2750	3000	3188
Up to 2050 4 Section	White	1902	2707	2833	2964	3228	3531	3637
	Wood/Trend Trend+	2289	3126	3253	3384	3648	3951	4057
	RAL	2532	3406	3533	3665	3928	4232	4338
Up to 2204 4 Section	White	1998	2833	2964	3104	3368	3672	3788
	Wood/Trend Trend+	2383	3253	3384	3522	3786	4090	4195
	RAL	2629	3533	3665	3803	4066	4367	4473
Up to 2320 4 Section Up to 2359 5 Section	White	2097	2964	3104	3250	3514	3817	3923
	Wood/Trend Trend+	2482	3384	3522	3670	3934	4237	4343
	RAL	2728	3665	3803	3950	4214	4518	4623

Maximum Over-Frame Size		50/50 split only			
Height	Width up to:	1250	2286	2438	2500
Up to 2050 4 Section	White	2137	4152	4290	4443
	Wood/Trend Trend+	2522	4571	4710	4863
	RAL	2803	4850	4991	5144
Up to 2204 4 Section	White	2224	4265	4405	4571
	Wood/Trend Trend+	2608	4685	4824	4991
	RAL	2854	4965	5105	5270
Up to 2320 4 Section Up to 2359 5 Section	White	2315	4385	4538	4751
	Wood/Trend Trend+	2700	4805	4958	5171
	RAL	2945	5086	5240	5451

## TREND COLOURS

TT9016 Bling White with micaeous iron ore particles glitter effect	Ice Crystal Grey Aluminium	White Aluminium RAL 9006	Grey Aluminium RAL 9007
Light Grey RAL 7035	Window Grey RAL 7040	Quartz Grey RAL 7039	Umbra Grey RAL 7022
Slate Grey RAL 7015	Anthracite Grey RAL 7016	*Anthracite Textured RAL 7016	TT 703 A special satin metallic effect (grey with micaeous iron ore particles)
Jet Black RAL 9005	Steel Blue RAL 5011	Moss Green RAL 6005	Fir Green RAL 6009
Flame Red RAL 3000	Sepia Brown RAL 8014	Cream RAL 9001	*Only available on smooth surface texture.

## NEW! TREND+ COLOURS

Agate Grey RAL 7038	Silver Grey RAL 7001	Pebble Grey RAL 7032	Stone Grey RAL 7030
Mouse Grey RAL 7005	Basalt Grey RAL 7012	Graphite Grey RAL 7024	Granite Grey RAL 7026
Graphite Black RAL 9011	Signal Black RAL 9004	Gentian Blue RAL 5010	Pigeon Blue RAL 5014
Chartwell Green BS 14 C 35	Sage Green RAL 130 60 10	Burgundy RAL 3004	Ruby Red RAL 3003
Terra Brown RAL 8028	Nut Brown RAL 8011	Light Ivory RAL 1015	Pure White RAL 9010

**Colours**

Where doors are exposed to direct sunlight, dark colours should be avoided.

RAL/BS references for colours are provided as a guide only to the nearest similar RAL/BS colour. Colours will not match to other RAL/BS finishes due to different coating processes, gloss levels, substrates and textures. Similarly, special RAL, BS, wood effects or other colours will not be a precise match.

\*RAL9006 and 9007 pose particular problems when colour matching, more information is available via the sales office.

Colours shown are limited in accuracy by the printing process - samples should always be requested.

If you are matching to other finishes, particularly wood effects such as rosewood, golden oak, night oak or Winchester, always request a sample.

**Frames & Door Leaf Frames**

Frames and door leaf frames in selected Trend colours & wood design are finished in a complementary flat colour:

Golden Oak (RAL8003),  
Rosewood (RAL8016),  
Night Oak (RAL8014),  
Winchester (RAL8001),  
Textured Anthracite (RAL7016)  
Ice Crystal Grey Aluminium (RAL9007)  
TT9016 Bling White (RAL9016).

Frames and door leaf frames are available in smooth finish only.

Prices are for a single colour to all components of the door. If you require a different colour for the frame to the door panel a surcharge will apply - please contact the office for details. As a guide, a different frame colour is charged at £20.00 per metre squared (overall door size).

**Traditional Doors**

Traditional Doors are supplied with mock leaded-effect windows as standard, applied to the external face of the window only. Different coloured leading is available (Black/White). Plain windows are available as a no-cost option - please specify your requirement when ordering.

**Open-Out / Open-In**

Doors supplied open-out as standard. Open-in is available as an option - please specify when ordering. NOTE: open-in doors increase the likelihood of water ingress.

**NEW!**

# POLYMER WINDOWS

WINDOWS - POLYMER DOUBLE GLAZING Polymer casement with polymer (Styrene Acrylonitrile) double glazed unit.

## Georgian



1 Rectangle Plain 1 Rectangle Cross Mullion 1 Rectangle Rhombus

## Standard Rib, Centre Rib & Solid



1 Rectangle Plain 1 Rectangle Cross Mullion 1 Rectangle Rhombus Rectangle 2 Rectangle 3 Vertical Square 1 Vertical Square 2 GSA Aluminium

Style	Overall Size	Colour / Finish	Price per Window
Rectangle 1	610 X 270	White Trend/Trend+/Ral/Wood design	£143 each £187 each
Rectangle 2	680 X 210	White Trend/Trend+/Ral/Wood design	£143 each £187 each
Rectangle 3	980 X 140	White Trend/Trend+/Ral/Wood design	£171 each £224 each
Square 1 & 2	270 x 270	White Trend/Trend+/Ral/Wood design	£143 each £187 each
GSA Aluminium Window Section	per linear m	White/Trend/Trend+ Ral/Wood design	POA POA

All polymer windows are available with these glazing options:

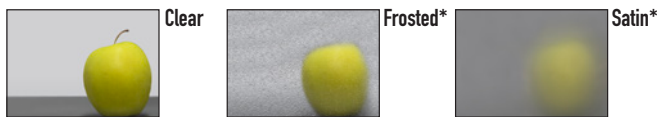

\*The exterior pane is Frosted/Satin and the interior pane is Clear.

### Polymer Windows

To price for windows fitted vertically down the door; square type 1 & 2, match windows to number of sections ie 4 sections = 4 windows).

Selected Trend colours & wood design windows are finished in a complementary flat colour for Golden Oak (RAL8003), Rosewood (RAL8016), Night Oak (RAL8014), Winchester RAL (8001), Textured Anthracite (RAL7016), Ice Crystal Grey Aluminium (RAL9007) and TT9016 Bling White (RAL9016).

The surrounds on aluminium GSA window sections are finished in a smooth finish. Window frame colour shade and surface lustre will show a variance from the panel finish as the base material and coating methods are different.

# ALUMINIUM WINDOWS & DECALS

ALUMINIUM WINDOWS - POLYMER DOUBLE GLAZING Aluminium and polymer casement with polymer double glazed unit.

### PRICE PER WINDOW

£352



Alpha  
280mm x 280mm



Sigma  
610mm x 200mm

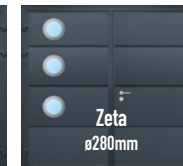

Zeta  
ø280mm



Gamma  
534mm x 344mm

### PRICE PER SET

£844



Kappa  
1860mm x 180mm

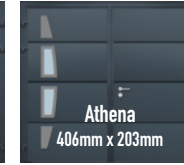

Athena  
406mm x 203mm

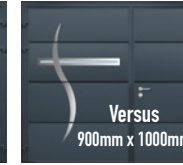

Versus  
900mm x 1000mm

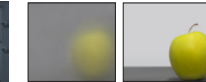

Satin Clear  
All aluminium windows are available with these glazing options (satin is supplied as standard).

Minimum over frame height for Kappa windows used vertically on side hinged doors: 2010mm

ALUNOX DECALS Factory bonded alunox decals. Decals can be positioned to requested positions, however, popular arrangements are shown here.

### PRICE PER DECAL

£61

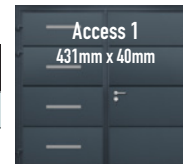

Access 1  
431mm x 40mm



Access 2  
430mm x 40mm



Access 3  
215mm x 40mm



Access 4  
400mm x 86mm

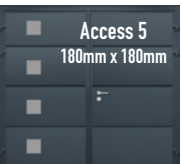

Access 5  
180mm x 180mm

### PRICE PER DECAL

£61

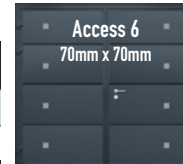

Access 6  
70mm x 70mm



Access 7  
150mm x 150mm



Access 8  
194 mm x 194 mm



Access 9  
436mm x 40mm



Access 10  
431mm x 13mm

### PRICE PER DECAL

100mm £55

### PRICE PER DECAL

200mm £61

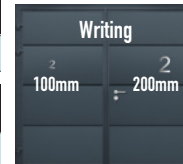

Writing

100mm 200mm

# POPULAR OPTIONS

\*\*For how to care for stainless steel see: [www.teckentrup.co.uk/garage-doors/frequently-asked-questions-faqs/stainless\\_care](http://www.teckentrup.co.uk/garage-doors/frequently-asked-questions-faqs/stainless_care)  
\*\*\*Black powder coated handles may chip with use.

## ACCESSORIES AND OPTIONS

Pull Handles Stainless Steel** 38mm 'D' Handles (Length)	1200mm	308 each	Drip Guard Recommended on inward opening doors	Single Leaf	80
	1500mm	364 each		Double Leaf	159
Black Powder Coated Lever Handle Supplied in place of Stainless Steel***		63	Three Point Locking (Active leaf) Minimum over frame height: 1950mm Horizontal doors / 2020mm Vertical doors		510
Lever Handle Upgrade 316 Stainless Steel Required for high salinity environments****		43	Additional Key Each Standard/Security		30 / 60
****Doors installed in coastal/high salinity environments must be fitted with this option. Doors with standard stainless steel or black handles may experience corrosion of the handle and discolouration of the surrounding door finish. This will be excluded from warranty claims.			Aluminium Strip Threshold Profile		-50
Foot Stops Supplied in place of door stays		FOC	Surface Mounted Hinges (In place of concealed hinges)		FOC

# EXTRA OPTIONS

## EXTRA TOUCHES

				Bespoke hardware fitting on request.
PET FLAP £48 fitting charge*	CODE LOCK £637	SPY HOLE £55	LETTER BOX From £83	

\*Customer supplied

# TECHNICAL CARTECK SECTIONAL GARAGE DOORS GSW 40-L & GSA/SLX VISION

## DIMENSIONS ORDERING SIZES = DRIVE THROUGH SIZES

Observe the following measurement details to guarantee exact assembly and precise, reliable operation of CarTeck sectional garage doors.

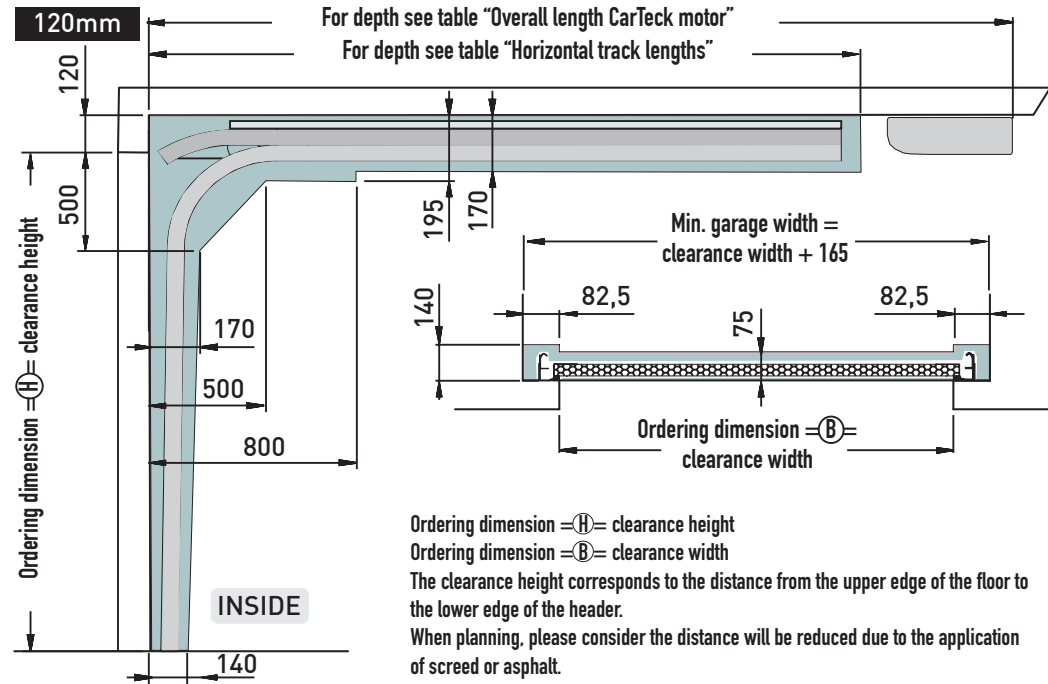

## RECOMMENDED HORIZONTAL TRACK FIXING POINTS

If the rear spacer bar extending side fixings are securely fixed, the second fixing point, shown within  $\bigcirc$  is not required.

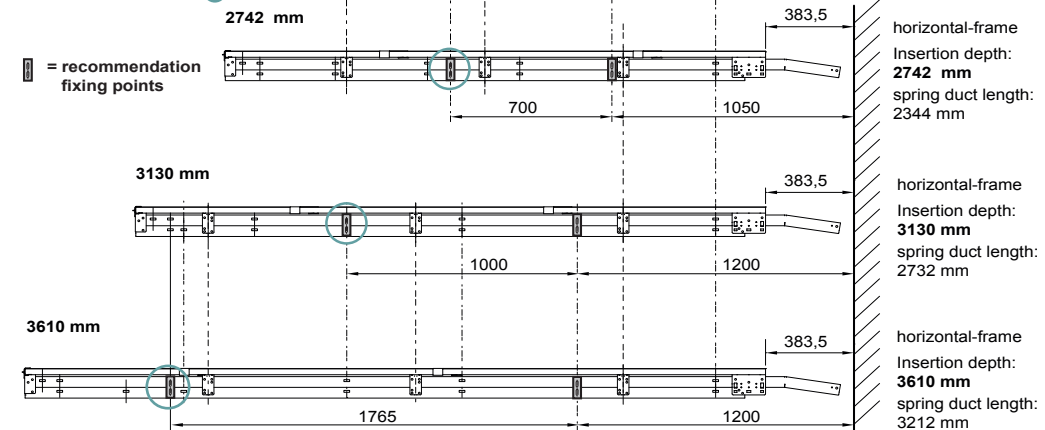

## ORDERING NOTES:

Door heights achieved by mixing panel heights (except ribbed), use of 0, 9, 17, or 32mm bottom profiles or top & bottom panel cut downs.  
When ordering use metric sizes, imperial conversions are nominal.

## Frame holes & fixing brackets

Height	Width																Height				
	2084	2134	2235	2286	2388	2438	2591	2743	3048	3353	3658	3962	4216	4267	4420	4572		4877	5182	5500	
3000																					3000
2875																					2875
2750																					2750
2625																					2625
2500																					2500
2375																					2375
2250																					2250
2204																					2204
2175																					2175
2125																					2125
2084																					2084
2050																					2050
2000																					2000
1925																					1925
1875																					1875
Height	Width																Height				

Requires frame leg holes (standard frame) and twist fix frame leg brackets.

Twist fix frame leg brackets not required, but provided to assist with installation\*.

No holes in frame leg as an option (between fix frame with stiffener brackets required).

Twist fix frame leg brackets required.

No holes in frame leg as an option (between fix frame with stiffener brackets required).

Standard frame leg hole position from edge of frame leg (seal side) to centre of fixing holes = 55mm.

\*Doors below 70kg do not require twist fix brackets for strengthening, however they are included with all doors to assist with installation. They can be used outboard of the frame to locate a secure fixing when inbound fixing is not possible or sufficiently solid.

## HORIZONTAL TRACK LENGTHS

$\square$  Allow 115mm headroom. Use standard lifting gear.  $\square$  Allow 140mm headroom above trays only. Gear uses twin springing & commercial roller spindles

Height	Width																Height				
	2084	2134	2235	2286	2388	2438	2591	2743	3048	3353	3658	3962	4216	4267	4420	4572		4877	5182	5500	
3000																					3000
2875																					2875
2750																					2750
2625																					2625
2500																					2500
2375																					2375
2250																					2250
2204																					2204
2175																					2175
2125																					2125
2084																					2084
2050																					2050
2000																					2000
1925																					1925
1875																					1875
Height	Width																Height				

3610mm

3130mm

2742mm

Horizontal tracks can be reduced on request for £176. Speak to the CarTeck sales office for limitations.

## SPECIFICATION

### GSW 40-L Sectional door

#### DOOR:

Sectional door double skinned PUR foam core, 40mm thick CarTeck panels. Outer surface finished in choice of 4 standard designs and all standard listed CarTeck colours. Inner surface stucco design, colour similar to RAL 9002. Sections have a centre seal: EPDM, header, and floor seals. Different order heights are made up from mixing panel sizes, 4 different bottom profile sizes and reduced top panel heights.

#### FRAME:

Door frame is made from galvanized sheet steel, coil coated with polyester, prime coated similar to RAL 9016 or other Trend colour. Protective strips with EPDM sealing lips on both sides of the vertical tracks.

#### HARDWARE:

Galvanised finish, screwed hinges to all sections, adjustable rollers with ball bearings. Multiple tension springs and double cable system housed in low friction housing above horizontal tracks.

#### AUTOMATION:

Door prepared for automation as standard with manual locking available as optional extra.

### COLOURS

RAL/BS references for colours are provided as a guide only to the nearest similar RAL/BS colour. Colours will not match to other RAL/BS finishes due to different coating processes, gloss levels, substrates and textures. Similarly, special RAL, BS or other colours will not be a precise match.

The door panel, frames and window frame colour shade, and surface lustre will show some slight variation, this is due to different base materials and coating methods.

### GSA / SLX Vision Sectional door

#### DOOR:

Sectional door panels made from hollow aluminium profiles, 40mm depth filled with 16mm scratch resistant, polymer double glazing. Sections have a centre seal: EPDM, header, and floor seals. Door heights are achieved by equal division of panel heights ranging from 300mm to 750mm.

#### FRAME:

Door frame is made from galvanized sheet steel, coil coated with polyester, prime coated similar to RAL 9016 or other Trend colour. Protective strips with EPDM sealing lips on both sides of the vertical tracks.

#### HARDWARE:

Hardware, galvanised finish, screwed hinges to all sections, adjustable rollers with ball bearings. Multiple tension springs and double cable system housed in low friction housing above horizontal tracks.

#### AUTOMATION:

Door prepared for automation as standard.

### COLOURS

RAL references for colours are provided as a guide only to the nearest similar RAL colour. Colours will not match to other RAL finishes due to different coating processes, gloss levels, substrates and textures. Similarly, special RAL, BS or other colours will not be a precise match.

The door panel, frames and window frame colour shade, and surface lustre will show some slight variation, this is due to different base materials and coating methods.

## NO HOLES FRAME FIXING

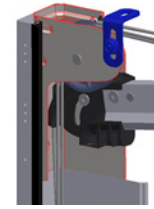

### IMPORTANT !

When fixing a no-holes frame between the reveal you must secure the frame to the lintel as shown using the 'L' bracket supplied.

If a good fixing cannot be achieved, alternative fixing methods must be used to secure the frame.



## CARTECK DRIVE 500 / 600 DIMENSIONS

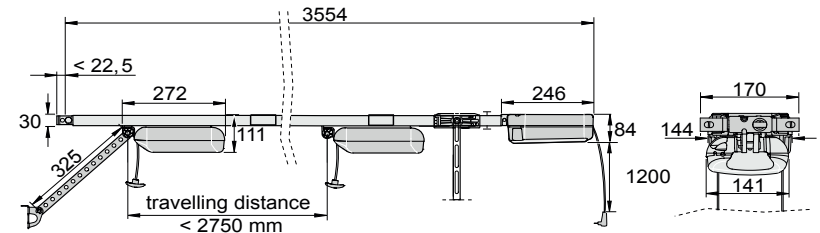

## CARTECK DRIVE PRO 500 / 600 DIMENSIONS

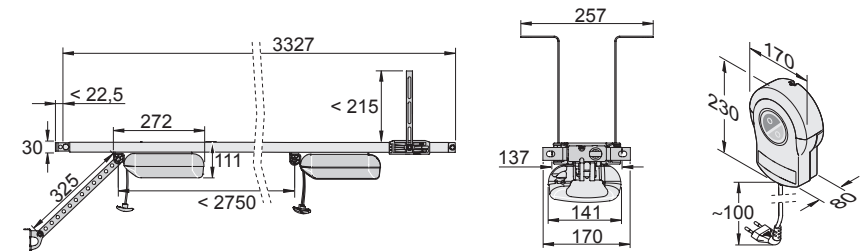

## OPERATOR RAIL FOR CARTECK 260/70/80 & 360/370/380

Turning motor head through 90 degrees reduces overall length: 200 series -133mm 300 series -18mm

Height	Carteck 260 / 360				Carteck 270 / 370				Carteck 280 / 380												Height
	2084	2134	2235	2286	2388	2438	2591	2743	3048	3353	3658	3962	4216	4267	4420	4572	4877	5182	5500		
3000	4296mm																		3000		
2875	4296mm																		2875		
2750	4296mm																		2750		
2625	4296mm																		2625		
2500	3536mm																		2500		
2375	3536mm																		2375		
2250	3536mm																		2250		
2204	3536mm																		2204		
2175	3536mm																		2175		
2125	3536mm																		2125		
2084	3286mm																		2084		
2050	3286mm																		2050		
2000	3286mm																		2000		
1925	3286mm																		1925		
1875	3286mm																		1875		
Height	2084	2134	2235	2286	2388	2438	2591	2743	3048	3353	3658	3962	4216	4267	4420	4572	4877	5182	5500	Height	
Width																					

## OPERATOR RAIL FOR CARTECK DRIVE & DRIVE PRO

Height	Width																		Height	
	2084	2134	2235	2286	2388	2438	2591	2743	3048	3353	3658	3962	4216	4267	4420	4572	4877	5182		5500
3000	Drive 4650mm Drive Pro 4423mm																		3000	
2875	Drive 4650mm Drive Pro 4423mm																		2875	
2750	Drive 4650mm Drive Pro 4423mm																		2750	
2625	Drive 4650mm Drive Pro 4423mm																		2625	
2500	Drive 4650mm Drive Pro 4423mm																		2500	
2375	Drive 4650mm Drive Pro 4423mm																		2375	
2250	Drive 4650mm Drive Pro 4423mm																		2250	
2204	Drive 4650mm Drive Pro 4423mm																		2204	
2175	Drive 4650mm Drive Pro 4423mm																		2175	
2125	Drive 4650mm Drive Pro 4423mm																		2125	
2084	Drive 3554mm Drive Pro 3327mm																		2084	
2050	Drive 3554mm Drive Pro 3327mm																		2050	
2000	Drive 3554mm Drive Pro 3327mm																		2000	
1925	Drive 3554mm Drive Pro 3327mm																		1925	
1875	Drive 3554mm Drive Pro 3327mm																		1875	
Height	2084	2134	2235	2286	2388	2438	2591	2743	3048	3353	3658	3962	4216	4267	4420	4572	4877	5182	5500	Height
Width																				

# TECHNICAL CARTECK SUPER SIZE SECTIONAL GARAGE DOORS GSW 40-L

## DIMENSIONS AND CLEARANCES

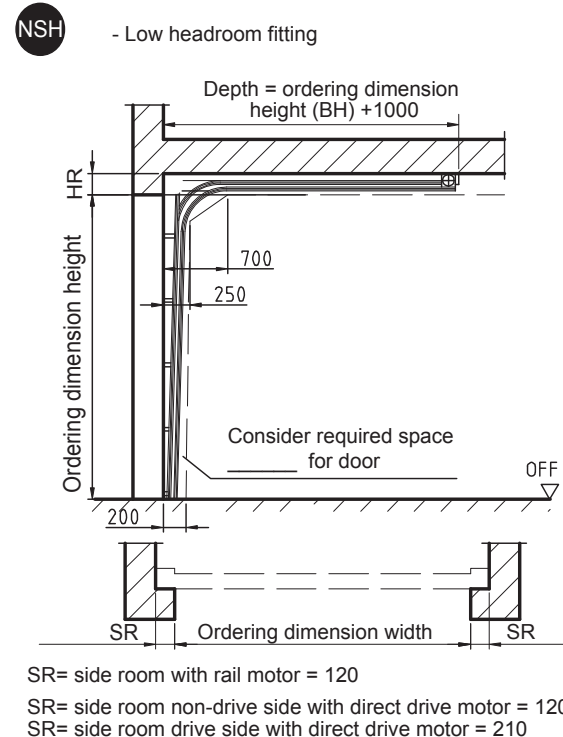
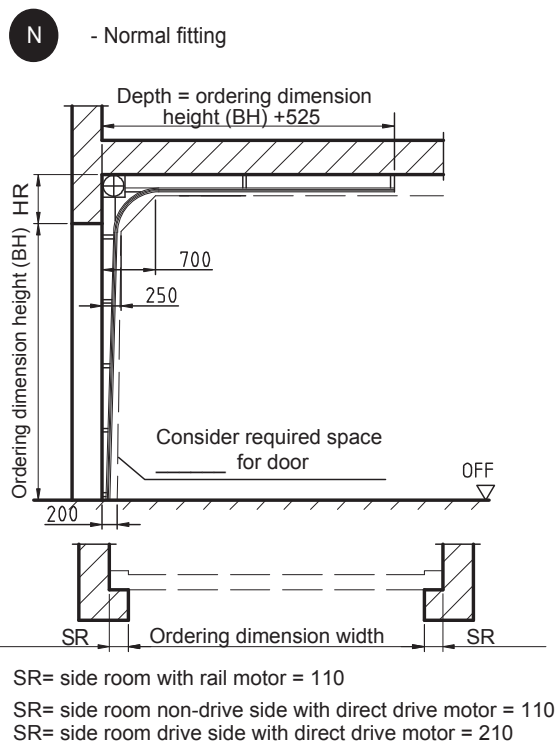

## HR HEADROOM REQUIREMENT

Heights				Widths				
				6000	6500	7000	7500	8000
<b>4</b> Sections	2250 7'4"	Rail Operator	Stand Headroom	400	450	-	-	-
		Direct Drive	Stand Headroom	400	450	450	450	450
			Low Headroom	300	300	-	-	-
			Low Headroom	280	280	280	280	280
<b>5</b> Sections	2750 9'0"	Direct Drive	Stand Headroom	400	450	450	450	450
			Low Headroom	280	280	280	280	280
<b>6</b> Sections	3000 9'9"	Direct Drive	Stand Headroom	400	450	450	450	450
			Low Headroom	280	280	280	280	280

Max Width For Low Headroom = 7750

300mm low headroom with rail operator is to prevent the top panel seal rubbing on the rail  
 If this is not an issue then the door will fit in 280mm

## SPECIFICATION

### DOOR:

Sectional door double skinned PUR foam core, 40mm thick CarTeck panels. Outer surface finished in choice of 4 standard designs and all standard listed CarTeck colours. Inner surface stucco design, colour similar to RAL 9002. Sections have a centre seal, EPDM, header, and floor seals. Different order heights are made up from mixing panel sizes, 2 different bottom profile sizes and reduced top panel heights. Doors have reinforcing steel profiles on the rear of the panels.

### FRAME:

Door frame is made from hot dipped galvanised steel sections. Protective strips with EPDM sealing lips on both sides of the vertical tracks.

### HARDWARE:

Doors have galvanised frame legs and are supplied without a header strip. Hardware has galvanised finish, screwed hinges to all sections, adjustable rollers with ball bearings. Front or optional rear mounted torsion spring with load-bearing steel cables. 1 pair of tension bars.

### AUTOMATION:

Electric 230V drive as standard, either direct or rail drive. Optical safety edge, hard wired to control system and photocells. Direct drive motor must have 13 amp supply direct to consumer unit. External release is not possible with direct drive motor, additional access must be available into garage.

### COLOURS

RAL references for colours are provided as a guide only to the nearest similar RAL colour. Colours will not match to other RAL finishes due to different coating processes, gloss levels, substrates and textures. Similarly, special RAL, BS or other colours will not be a precise match.

The door panel, frames and window frame colour shade, and surface lustre will show some slight variation, this is due to different base materials and coating methods.

# TECHNICAL CARTECK SIDE HINGED GARAGE DOORS GSW 40-L

## GEORGIAN DOORS

Horizontal doors have 2 columns of features as standard arranged 1/2 - 1/2, changing to an asymmetric three columns at the width shown below. 1/2 - 1/2 vertical doors have 2 rows of features as standard changing to three at the height shown right.

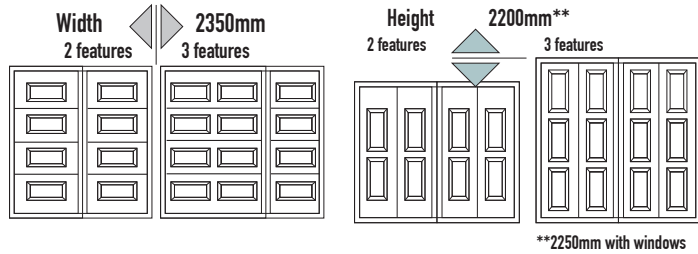

## SPECIFICATION

### DOOR:

Door leaves are fabricated using 40mm thick CarTeck panels with an extruded aluminium perimeter frame and integral seals. Doors with the optional standard threshold profile have an EPDM black threshold seal at the base. Each leaf is fitted with two concealed hinges. Large doors and doors with asymmetric leaves may have three hinges per leaf.

The door frame is an extruded aluminium profile with mitred corners and integral seals. For details refer to technical leaflet. A 3-part stepped aluminium threshold is also included. 10mm tolerance should be allowed to facilitate frame squaring during installation.

Doors supplied open-out as standard. Open-in is available as an option - please specify when ordering. NOTE: open-in doors increase the likelihood of water ingress. We recommend the drip guard option is selected with open-in doors.

### HARDWARE:

Hardware comprises of a DIN standard CE marked European sashlock and a pair of stainless steel round bar lever handles on 50mm diameter roses. A Euro-profile cylinder and thumb turn with stainless steel escutcheons is included as standard (double cylinder, key both sides is available as an option if required). Three keys are supplied with each cylinder. The inactive leaf is fitted with top and bottom recessed lever action flush bolts. A stay is fitted to each leaf to hold the door in the open position, any leaf below 780mm wide (including asymmetric side hinged doors) will not have a stay. Stainless steel\*\* needs regular cleaning or will stain, especially in areas of high salt content. Doors installed in coastal/high salinity environments must be fitted with a 316 Stainless Steel lever handle upgrade. Doors with standard stainless steel or black handles may experience corrosion of the handle and discolouration of the surrounding door finish. This will be excluded from warranty claims.

### COLOUR:

The door frame and window frame colour shade and surface lustre will show a variance from the panel finish as the base material and coating methods are different. Where differing materials and process are adopted, such as side hinged GSW 40L garage doors, there may be some colour matching variations. Differing light conditions may further reduce or highlight this effect. The colours RAL9006 and 9007 pose particular problems when colour matching, more information is available via the sales office.

RAL/BS references for colours are provided as a guide only to the nearest similar RAL/BS colour. Colours will not match to other RAL/BS finishes due to different coating processes, gloss levels, substrates and textures. Similarly, special RAL, BS or other colours will not be a precise match.

\*\*For how to care for stainless steel see: [www.teckentrup.co.uk/garage-doors/frequently-asked-questions-faqs](http://www.teckentrup.co.uk/garage-doors/frequently-asked-questions-faqs)

## DIMENSIONS AND CLEARANCES

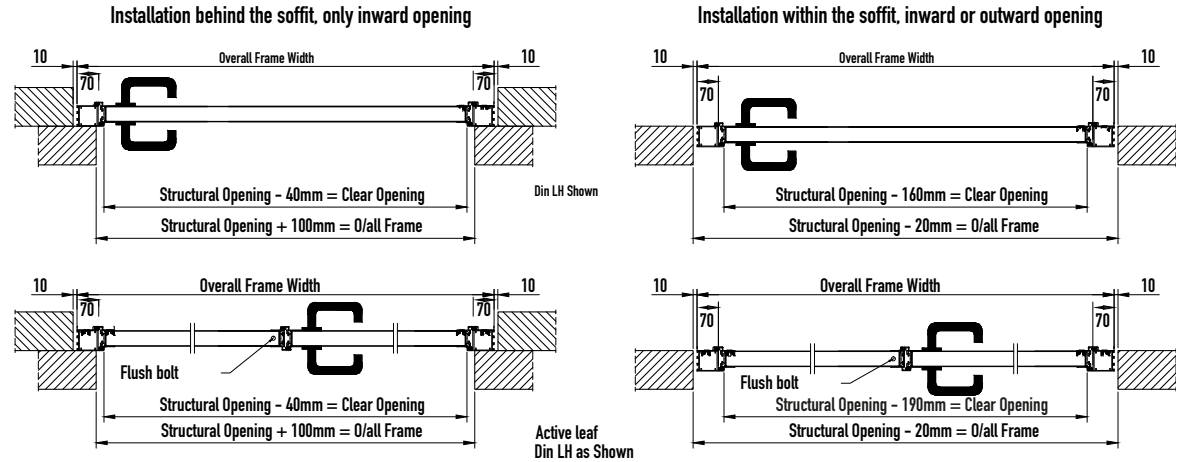

## CLEARANCES

### IMPORTANT

When doors are ordered as a structural opening size, Teckentrup UK will deduct 20mm from the width and 10mm from the height for coursing tolerance. If this is more tolerance than you wish, please state the over-frame dimension you require.



The section height and the height of the handle 'x' depend on the actual door height and construction of the door.

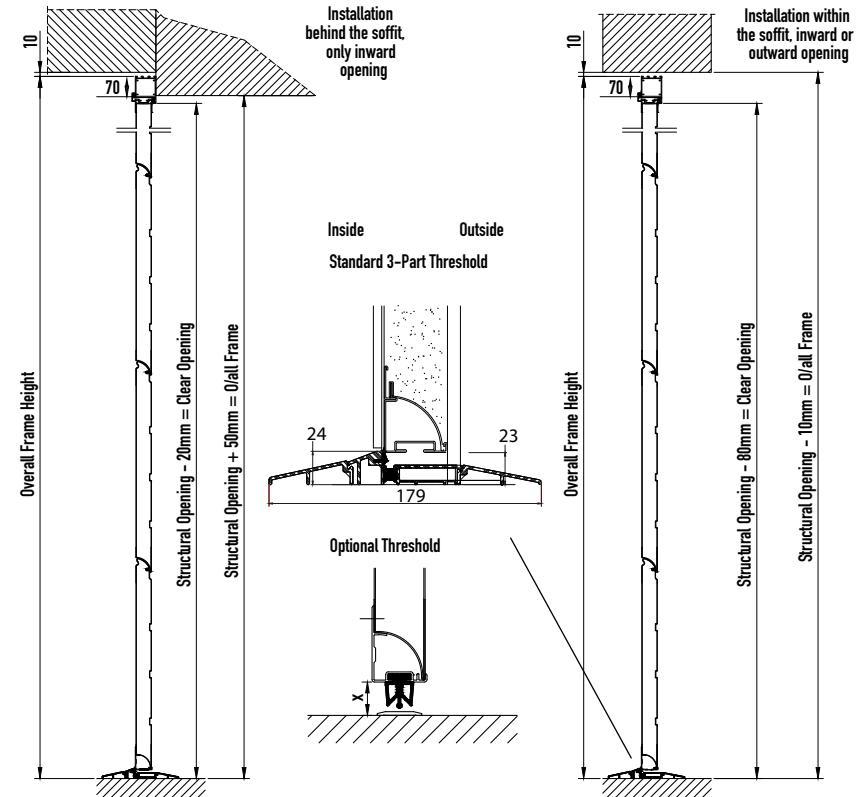

# FITTERS TIPS SECTIONAL DOORS

## FRAME TYPES & BETWEEN FIX

### Which Frame type?



#### Standard Frame (with back fixing holes)

Use this frame for:

- **Back-fix**
- **Part-within fix**  
show up to 48mm of frame leg within the opening
- **Between the reveal fix**  
In conjunction with 3D profile covers



#### Between Fix Frame (without back fixing holes)

Use this frame for:

- **Between the reveal fix**  
Up to a maximum size of 5500mm (18'0") wide and 2250mm (7'4") high

**Does not require 3D cover profiles**

### Optional extra accessories to make between fix easy:



Kit Shown used with L shaped bracket



Bracket and fixings

**Twist fix header kit** When fitting between the reveal the frame header must be secured. The kit includes a pair of brackets that facilitate a solid fix for the header by providing a fixing point for "L" shaped brackets.

**Between fix kit** The kit includes brackets that allow a fixing to be made behind the frame leg and is suitable for both the standard frame and between fix frame. The kit also includes white grommets for filling exposed frame fixing holes if you are using a standard frame.

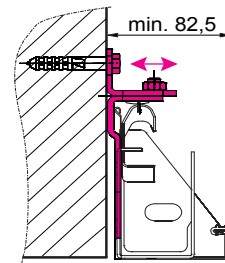

Between fix bracket shown from both sides on a no-hole frame leg.

## BETWEEN FIX

There are things you must do to ensure a sound installation on a no-holes frame:

**YOU MUST USE THE LINTEL FIXING TO SECURE THE TOP OF THE FRAME LEG OF A NO HOLE FRAME\***



**Pre-fitted Lintel fixing brackets** - **IMPORTANT!** These must be used to secure the top of the frame leg, preventing lateral movement. If you can't use the bracket you must find an alternative means to secure the frame leg.

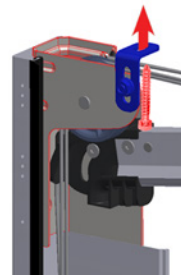

**Stiffener brackets** must be fitted to ensure the frame legs are prevented from twisting.

**\*Not required on standard frame between fix.**

**L Shaped brackets** Our L shaped brackets are supplied in pairs and might be just the job for securing that header in conjunction with the twist fix header kit!

## FITTING TIP!

Before you fit the frame, fit the track curves to the legs, finger tight, so that when you position the frame between the reveal and access with a spanner is narrow, all the nuts will need is a nip to tighten!

Not sure what you need? Talk to the team about our between fix solutions!

## COLOUR TIP!

If you're fitting part within or fully within the reveal and you want your frame and header to match the door, don't forget to order a colour matched frame and header! See the notes on colour on the pricing pages to confirm which colours are available.

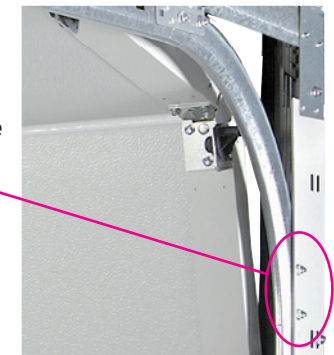



**3D profile kits** These profile kits not only provide a neat solution for covering frame holes on standard frames but also allow gaps to be bridged and overlap onto the opening face to neaten up edges. The profiles are supplied in 3m lengths for on-site cutting to size. Doors >3m will require a butt joint on the header, for a seamless header choose the 850r 120mm 3D frame leg kit and additional header.

**The kits:**

85mm frame leg kit	2no. 85mm x 12mm x 3000mm
85/120mm 3D profile kit	2no. 85mm x 12mm x 3000mm 1no. 120mm x 12mm x 3000mm
120mm 3D profile kit	3no. 120mm x 12mm x 3000mm
*85mm frame leg kit & additional door header	2no. 85mm x 12mm x 3000mm (The additional door header will be supplied to the door ordering size +200mm)
*120mm frame leg kit & additional door header	2no. 120mm x 12mm x 3000mm (The additional door header will be supplied to the door ordering size +200mm)
70mm angle 3D kit	3no. 70mm x 12mm x 3000mm

\* For doors over 3 metres wide – additional door header eliminates the join that would occur using a 120mm 3D profile (max length 3 metres)

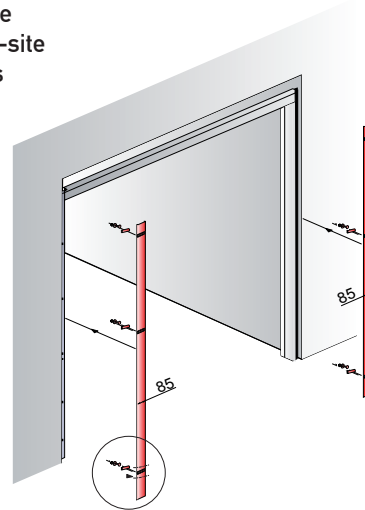

The 3D profiles have a smart fixing that allows for lateral movement – perfect for bridging small fitting gaps or tidying up the front face of the opening.  
Shown here on the 85mm 3D profile.

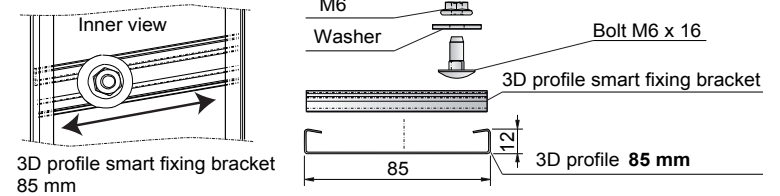

**85mm frame leg 3D profile kit**

85mm frame leg 3D cover profiles for between the reveal fit with lateral movement for up to 30mm gap coverage or up to 30mm overlap.

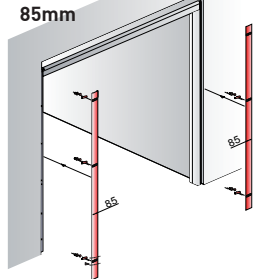
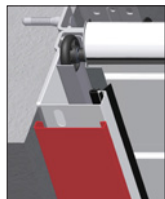

**85mm/120mm 3D profile kit**

Also available in a kit with a 120mm header 3D cover profile.

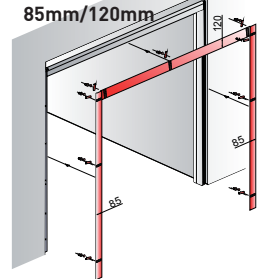

**120mm 3D profile kit**

120mm 3D cover profiles for between the reveal fit at the front edge with lateral movement for up to 65mm overlap.

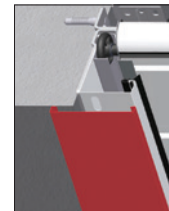
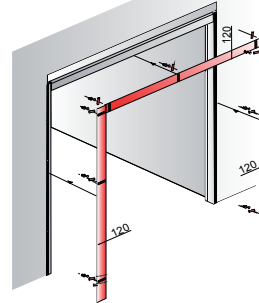

**85/120mm 3D frame leg kit & additional door header**

Perfect for doors over 3000mm wide – our 120mm 3D profile comes in 3000mm lengths requiring a butted joint on the header for larger doors – this kit includes a second full-width single piece header for a seamless finish. Choose kits with either 85mm or 120mm frame legs.

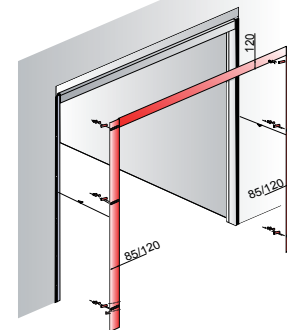

**70mm angle 3D renovating profile**

Use this when fitting behind the reveal or part between to neaten up damaged openings. The 70mm angle 3D renovating profile is held between the frame and the brickwork and will cover the back corner of the opening to tidy up any damaged wall edges. Ideal when removing timber frame and brick work deteriorated. Supplied in 3000mm lengths for on-site cutting to the required length.

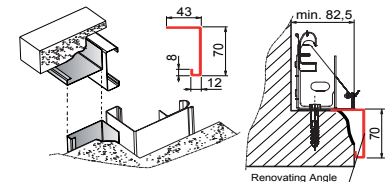
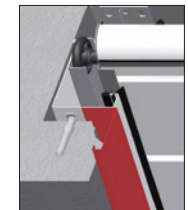

**Note:** The frame leg 3D kit profiles are 12mm deep and will create a step at the header. Use an 85/120 3D profile kit for a flush finish.

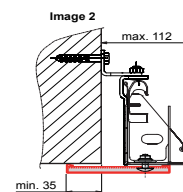
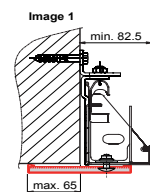
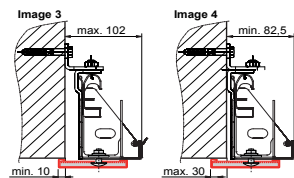
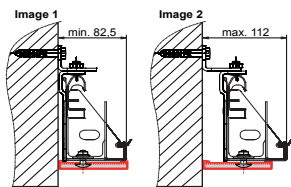

# FITTERS TIPS SECTIONAL DOORS

## USEFUL OPTIONS AND FITTING INFORMATION

**240mm headroom kit** This simple bracket lifts the tracks up an additional 120mm – great for getting over a gas meter or when a pass door comes into the garage – and it's free of charge. Just make sure you request it when ordering!

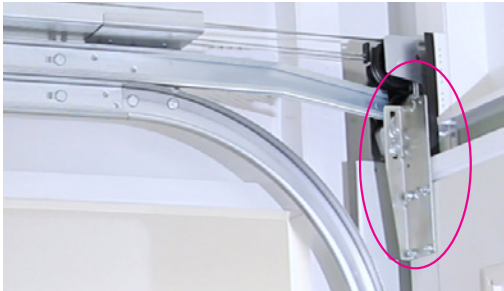

**Spacer Bar Suspension Plates** This bracket is needed when fitting a CarTeck DRIVE motor and you need to keep the motor within 120mm headroom. It allows the spacer bar to be lowered by 20mm (page 8 for pricing)

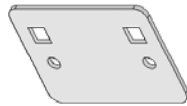

**Twist fix frame leg retaining brackets** Twist fix brackets are supplied with every size door but are not required on doors up to 2743mm (9'0") wide and 2250mm (7'4") high and under 70kg (You just fix straight through the frame fixing points for a secure and solid frame installation). Doors over this size do require twist fix brackets, they add rigidity to stop frame deflection.

Although not required on some doors, all fixing packs include them to assist with installation. They can be used outbound of the frame to locate a secure fixing when inbound fixing is not possible or sufficiently solid.

### Why twist fix?

Simple – they just locate through the frame and twist into position ready for fixing through. No fiddly nut and bolt to secure each bracket, just a super quick twist, fix and done!

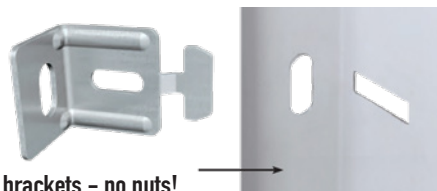
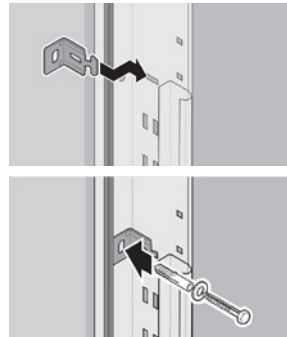

Twist fix brackets – no nuts!

### Header positioning options on the frame legs

The two groups of three fixing holes at the top of the frame leg allow the header to be fixed at different levels relative to the top of the frame leg.

0mm sits flush with the top of the frame leg - the standard position.

-10mm sits 10mm down from the top of the frame leg.

-20mm sits 20mm down from the top of the frame leg.

-10mm and -20mm allow you to show an amount of header below the lintel when back fixing. This is useful if you want to even up the appearance when frame legs are showing within the reveal.

You can also use these positions to drop the header if the door is sitting low in the tracks to ensure the top panel closes against the top seal without a gap.

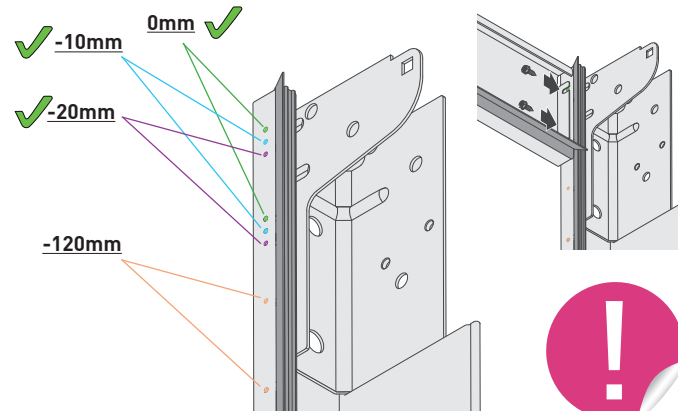

-120mm sits 120mm down from the top of the frame leg.

Use this position when fitting a 240mm headroom kit - it drops the header down 120mm to align with the top of the door panel.



### Fitting videos

Fitting your first door, need a refresher or just want to pick up a few tips - watch the full job or jump to a specific section, it's a great supplement to the paper fitting instructions.

Sectional Garage Door Fitting



# FITTERS TIPS SIDE HINGED DOORS

## SIDE HINGED

### Wind-out lugs to the side hinged frame for fast and easy frame setting

Position the frame in the opening, wind out the lugs with a 4mm allen key until the frame is true, level and square... ..and you're ready to fix.

No more fiddling with wedges or packers to get things set. Simple and fast frame setting! Up to 20mm of adjustment is possible on each side of the frame.



8 lugs per side

4mm allen key

Do not use an impact driver or power tools to extend the lugs. Use a manual allen key ONLY!



2 lugs at each of the four fixing points per side.



Lugs are accessed through the frame fixing hole.

### 316 Stainless steel handles for coastal/high salinity locations

Doors installed in coastal/high salinity environments must be fitted with a 316 Stainless Steel lever handle upgrade. Doors with standard stainless steel or black handles may experience corrosion of the handle and discolouration of the surrounding door finish. This will be excluded from warranty claims.



### Concealed hinges

Doors are supplied with two or three concealed hinges per leaf, dependent on size. With no hinges at the edge of the frame, trimming up your opening is easy.

The concealed hinges are very easy to adjust, see for yourself:



CONCEALED HINGE ADJUSTMENT VIDEO - SCAN ME!

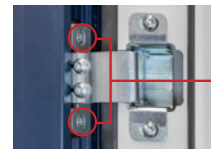

#### Vertical alignment

Use a T25 Torx to loosen these two screws to allow the leaf to move up and down in the frame profile, then tighten. All hinges will require adjustment.

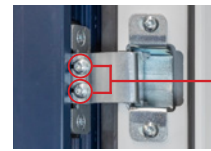

#### Leaf-to-frame clearance

Use a T25 Torx to loosen these two screws, align using the slotted hole, then tighten. One or all may require adjustment.

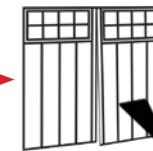
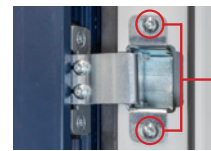

#### Gasket clamping force

Use a T25 Torx to loosen these two screws, align using the slotted hole, then tighten. One or all may require adjustment.

### Trimming up

Concealed hinges make trimming up simple. If your trim overlaps onto the frame, ensure it is <10mm thick. Trim thicker than 10mm will foul the arc of the door leaf preventing full opening.

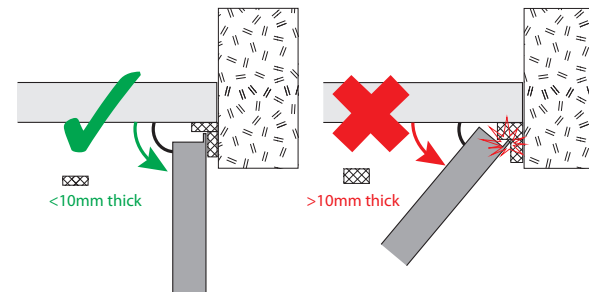

### Fitting videos

Fitting your first door, need a refresher or just want to pick up a few tips - watch the full job or jump to a specific section, it's a great supplement to the paper fitting instructions.

### Side Hinged Garage Door Fitting



# GENERAL SPARES

GENERAL SPARES		
	Price	Per
<b>SECTIONAL</b>		
Bottom rubber	26	m
Side seals	31	ea
Top seal	13	m
Bottom profile 0mm	31	m
Bottom profile 9mm	38	m
Bottom profile 17mm	45	m
Bottom profile 32mm	60	m
Top panel cut down profile	31	m
Bottom panel cut down profile	31	m
Panels use width of 4 section equivalent	20%	of total door price
Legs	243	ea
Horizontal Tracks	214	ea
Tray covers	74	ea
Spacer bars	31	m
Headers	38	m
Cables	74	pr
Springs	31	ea
Spring clips	11	ea
Rollers/pulleys/shreave wheels	17	ea
Spring tensioners (thread/nuts/hooks)	31	ea
Intermediate brackets	45	ea
Bottom brackets	45	ea
Centre hinges	16	ea
Top roller bracket including roller	45	ea
<b>SIDE HINGED</b>		
Raised threshold (including internal & external ramps)	133	m
Door stay (header bracket not included)	133	ea
Door stay header bracket white	12	ea
Door stay header bracket coloured	29	ea
Door stay grease pack of 20	12	ea
<b>WINDOWS</b>		
Window front white	60	ea
Window front painted	115	ea
Window glass (polymer)	60	ea
Window back	60	ea
Windows screws (14)	11	pk

Teckentrup is a family business with operations throughout the world. In the UK Teckentrup is based in Warrington, Cheshire. Teckentrup products are available through a national network of independent Garage Door Specialist installers.

Teckentrup offers more than garage doors: We provide solutions and have set three quality standards for our garage doors:



## Design

**We combine ease of use with aesthetics.**

Good design uses innovative technology to make using a product intuitive and effortless. Teckentrup garage doors offer a wide range of design options that will transform the look of your home and the way you use your garage space.



## Safety & Security

**We combine security with safety.**

Our products are designed to provide peace of mind with both physical security and the knowledge that durability and safe operation are inherent.



## Service

**We combine speed with reliability.**

The Teckentrup team and our network of Garage Door Specialist installers love to make your new door a pleasure to own. You'll always receive expert advice and the best service for installation, maintenance and aftercare.

**Teckentrup UK Limited,  
Units 2-4 Opus 9 Industrial Estate,  
Woburn Road, Winwick Quay Warrington WA2 8UE**

**www.teckentrup.co.uk**  
**t: 01925 924 050**  
**f: 08701 314 843**  
**e: sales@teckentrup.co.uk**

**TECKENTRUP**  
DOOR SOLUTIONS

# Design. Security. Service.

## Quality & Environment

Teckentrup operates to quality procedures audited to ISO 9001.

We care about the environment too - this is why our products are certified in accordance with the Environmental Product Declaration (EPD).

ISO 14001 Environmental Management  
ISO 50001 Energy Management



**DGNB**  
Deutsche Gesellschaft für Nachhaltiges Bauen e. V. German Sustainable Building Council

**BNB**  
Bewertungssystem Nachhaltiges Bauen - Evaluation system for sustainable building

**LEED**  
Leadership in Energy and Environmental Design

**BREEAM**  
Building Research Establishment Environmental Assessment Methodology



Raising Standards  
Safety Assured  
Member



CONTRACTOR HEALTH & SAFETY ASSESSMENT SCHEME  
Accredited Contractor  
www.has.co.uk



NBS Source

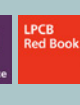

LPCB Red Book



LPCB



Constructionline